

This is new in Smap3D Plant Design 2022

Once again, the latest version of Smap3D Plant Design contains many enhancements and improvements in the areas of functionality and application.

The most important ones are described below.

The different chapters in this document are:

- [General news](#)
- [New in P&ID](#)
- [New in Component Wizard](#)
- [New in 3D Piping](#)
- [New in the P&ID To-Do List](#)
- [New in Isometric](#)

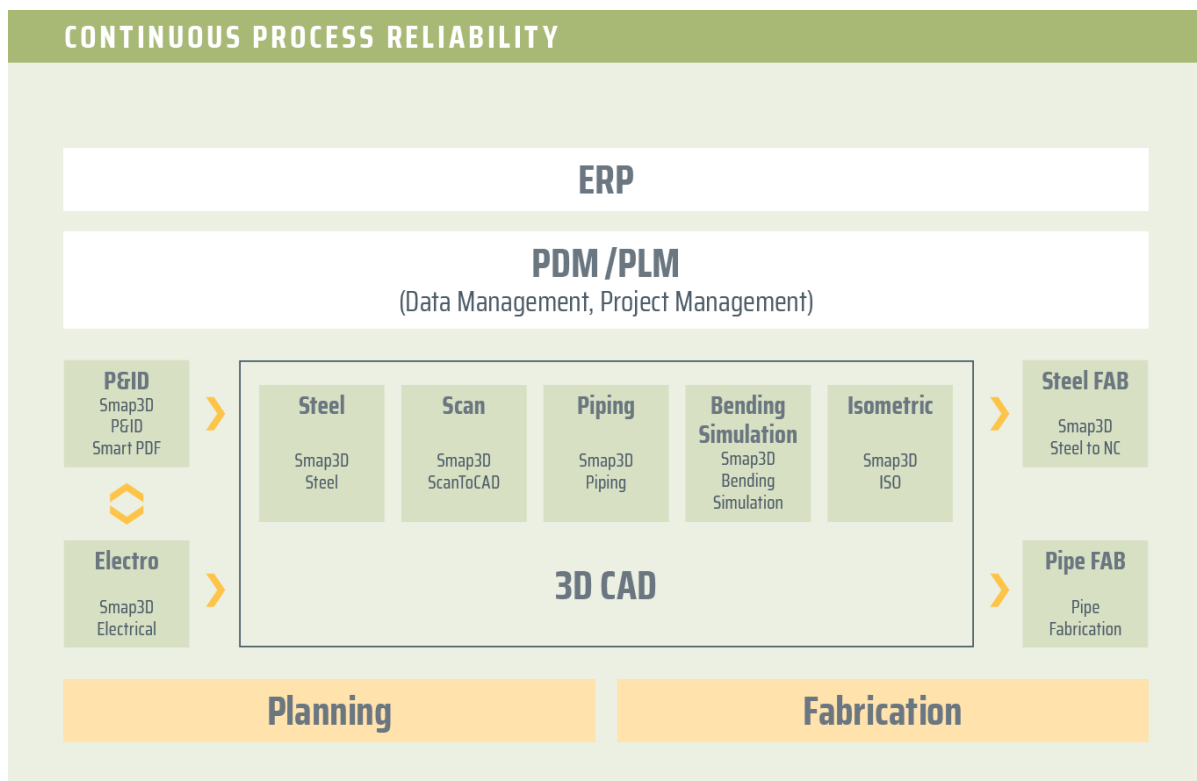

Table of Contents

TABLE OF CONTENTS	2
GENERAL IMPROVEMENTS	4
SUPPORTED CAD VERSIONS	4
LICENSING REQUIRED IN VERSION 2022.....	5
NEW PRODUCT LICENSES REQUIRED FOR VERSION 2022	5
INFORMATION MESSAGE WHEN ACTIVE LICENSE EXPIRES SOON	6
DIVIDED, NEW PROGRAM GROUP FOR PLANT DESIGN APPLICATIONS	6
NEW IN SMAP3D P&ID	8
NEW MODULE "EDIT LINES DATAFIELDS"	8
NEW SYMBOL DATA FIELDS FOR SEPARATE DISPLAY OF ASPECT VALUES	9
NEW OPTION "VISIBLE" FOR REFERENCE DESIGNATIONS IN THE NAME DATA FIELD	11
NEW, ADAPTED PCE SYMBOLS TO ISA 5.1 AND EN 62424	13
SYMBOL TITLES CAN BE DEFINED FOR ALL LANGUAGES.....	14
CHANGING THE USER INTERFACE LANGUAGE ALSO CHANGES COUNTRY CODE.....	15
SYMBOLS OF EN ISO 10628 AND EN 1861 WITH SYMBOL TITLE FOR DE AND US.....	16
"REPLACE ALL SYMBOLS" NOW ALSO UPDATES SYMBOL DATA FIELDS	17
COMMAND LINE FUNCTION FOR SPECIAL FUNCTION "REPLACE ALL SYMBOLS".....	18
NEW "COUNT VALUE" OPTION IN THE "RENAME SYMBOLS" FUNCTIONS	19
"OBJECT DATA" BUTTON AVAILABLE DIRECTLY IN THE DESIGN CHECK DIALOG	21
"RENAME" DIALOG FOR OBJECT GROUPS SHOW TEXT OF PREVIOUS NAME.....	22
NEW SPECIAL FUNCTION "SET PROJECT START TIME TO NOW"	23
DEFAULT SYMBOLS AND TEMPLATES FOR DRAWING BORDERS AND TITLE BLOCKS CHANGED	24
NEW FUNCTION "UPDATE REFERENCES" FOR VISIBLE DATA FIELD VALUES OF FORMULAS.....	24
NEW IN SMAP3D PARTS MANAGEMENT	25
DATABASE ADMINISTRATOR DISPLAYS USER-DEFINED CHARACTERISTICS IN SELECTION LISTS	25
NEW IN COMPONENT WIZARD	27
NEW COMPONENT TYPES WITH ADAPTED PREPARATION STEPS	27
LAST USED PART PROVIDER PRESELECTED	28
NEW IN SMAP3D PIPING	29
IN BASIC ENGINEERING MODE THE GENERATION OF CONCENTRIC REDUCERS IS POSSIBLE	29
NEW FUNCTION "SWITCH ALL TO DETAIL ENGINEERING"	30
"FINISH AND SAVE" FUNCTION NOW CONFIGURABLE	32
PLACE SPLIT POINT FOR ISOMETRIC NOW ALSO WITH FITTINGS.....	33
FUNCTION "UPDATE ALL CUSTOM OCCURRENCE PROPERTIES" NOW ALSO IN "REFRESH ALL SUBASSEMBLIES"	34
DESIGN CHECK "CS INFO" ONLY CHECKS THE NUMERICAL VALUES.....	35
PIPE SPECIFICATION EDITOR ALLOWS COPYING ROWS TO KEY NAME "UNION"	35
NEW IN THE P&ID TO 3D CONNECTION (P&ID TO-DO LIST)	36
P&ID COMPONENT ID IS NOW USED AS UNIQUE IDENTIFIER	36
NEW VIRTUAL CHARACTERISTIC "PID_C_DISPLAYNAME"	37
NEW CONFIGURATION OPTIONS FOR DISPLAYING ASPECTS OF REFERENCE DESIGNATIONS	38
TO-DO LIST SORT REDUCTIONS AFTER INNER EQUIPMENT	40
ENHANCED OPTION "RUN RECALCULATE OR EDIT AFTER PIPELINE ASSIGNMENT"	41
FUNCTION "PLACE 3D MODEL TO CAD" CAN USE P&ID DATABASE ENTRIES PARTPROVIDER AND PARTID	42

NEW IN SMAP3D ISOMETRIC	43
NEW INTERFACE FOR "POST-PROCESS PLUGINS"	43
NEW INTERFACE FOR USING EXTERNAL SCRIPTS IN FEATURE OVERRIDES.....	45
STANDARD FEATURE OVERRIDE PLUGIN FOR "PYTHON SCRIPT LANGUAGE".....	47
SUPPORT OF REDUCERS WITH FABRICATED BRANCHES AS INDIVIDUAL PARTS.....	48
SUPPORT OF ELBOWS WITH FABRICATED BRANCHES AS INDIVIDUAL PARTS	50
PIPELINE PATH MARKED IN ISOMETRIC WINDOW IS HIGHLIGHTED IN 3D CAD.....	51
MAPPING OF PROPERTIES OF A PATH TO THE PLACED COMPONENTS	52
ISOMETRIC READS PROPERTY OCCURRENCE NUMBER OF COMPONENTS.....	53
NEW OPTION TO SET FILE EXTENSION FOR PURGING.....	54
IMPRINT	55

General improvements

Supported CAD versions

Solid Edge

The release version of Smap3D Plant Design 2022 supports:

- **Solid Edge 2021 with Maintenance Pack 9 or later**
- **Solid Edge 2022 with Maintenance Pack 2 or later**

Licensing required in version 2022

With Smap3D Plant Design 2022, the CAD-Partner Licensing software (License Server Manager and License Client Manager) must also be installed in version 2022.

Existing **License server installations** of CAD-Partner Licensing (when using floating and/or multiple node-locked licenses) must **be updated to version 2022**. For details, refer to the **Installation Guide (in chapter > Upgrade)**, included in the installation package of version 2022.

This **will upgrade** an existing installation of License Server Manager 2021 **to version 2022**.

The updated version number of License Server Manager 2022 will then be **7.22.0.9**.

The name of the associated service is then **CAD Partner License Server 2022**.

The associated **FlexNetPublisher** version will be **11.17.1.0**.

All local License Client Managers, along with the Smap3D applications, must be uninstalled before an installation of Plant Design 2022 for client computer can be performed.

New product licenses required for version 2022

The Plant Design 2022 applications can only work with licenses issued for version 2022.

For this reason, customers with a valid maintenance contract will receive a customer-specific mail with the download link of the new version 2022, as well as the associated **new customer-specific license file** (for the hardware ID known to us).

Information message when active license expires soon

All Smapp3D Plant Design and Parts Management applications now display a license information message at startup **when the active license** (e.g., a temporary license, directly after the purchase if we do not know a hardware ID yet, or also in case of temporary rental licenses) **expires in the next 10 calendar days**.

Users and administrators receive the information they need to act promptly before their license expire.

Divided, new program group for Plant Design applications

Due to the large number of individual applications and the associated program group entries, the previous contents of the CAD-Partner program group have been changed and divided.

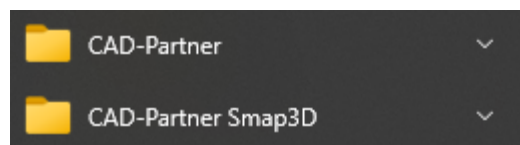

In the program group **CAD-Partner**, which we have created for many versions, there are now only the program links for the installed applications of the **CAD-Partner Licensing** and **Smapp3D Parts Management**.

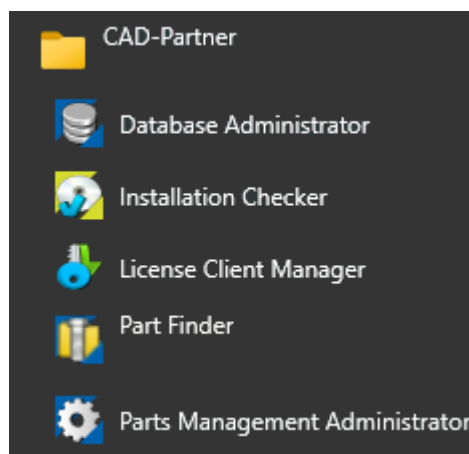

The new program group **CAD-Partner Smapp3D** now contains the program links of the installed applications of **Smapp3D Plant Design**.

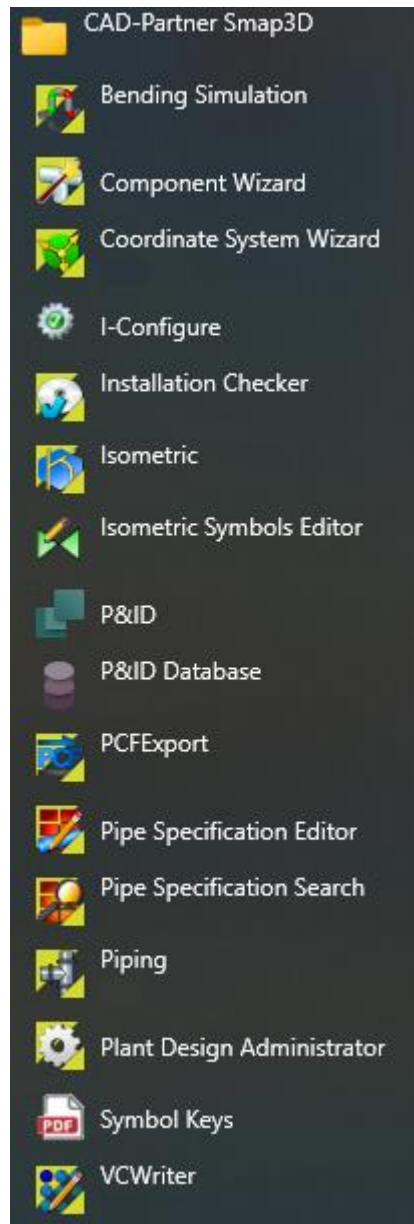

New in Smapp3D P&ID

New module "Edit lines datafields"

The **Tools** menu contains the new **Edit lines datafields** module.

This provides a user with a new tool for quick and easy bulk editing of line data field values.

The usage, as well as the available options in the **Edit contents** tab, are almost identical to the Edit symbols datafields module.

This allows bulk editing of line data field values, for all existing **conducting lines** in the active project (Entire project), or only the active diagram page (Current page).

Without this new option, a user previously had to edit the data field values individually on each line.

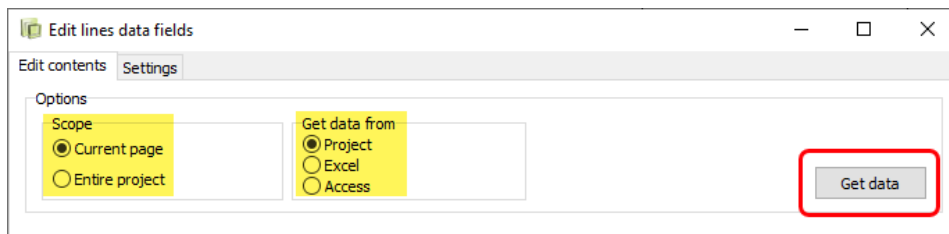

The input and editing of the lines data field values (for the listed lines) can be done directly in this window, or also externally after exporting to a **Microsoft Excel** or **Microsoft Access (MDB)** file.

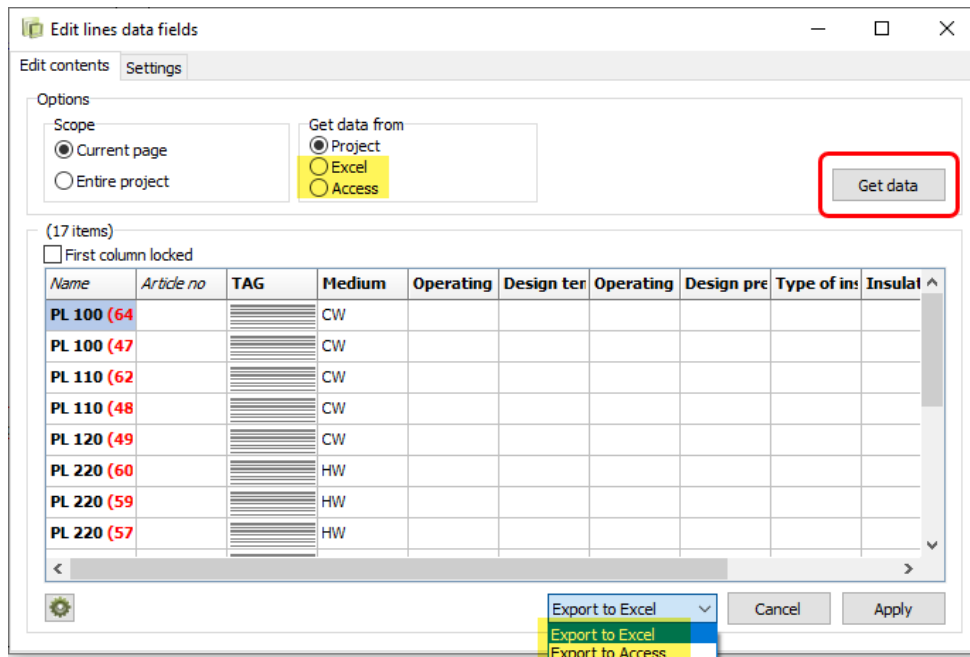

After external editing, the modified files can be loaded back into this module via **Get data**, and then written back to the lines using the **Apply** button.

New symbol data fields for separate display of aspect values

When defining symbols, three new symbol data fields named **(1)=+-design.**, **(2)=+-design.**, and **(3)=+-design.** are available.

With these it is now possible to realize the display of single/separated aspect values of a reference designation in a symbol (e.g., PCE symbols).

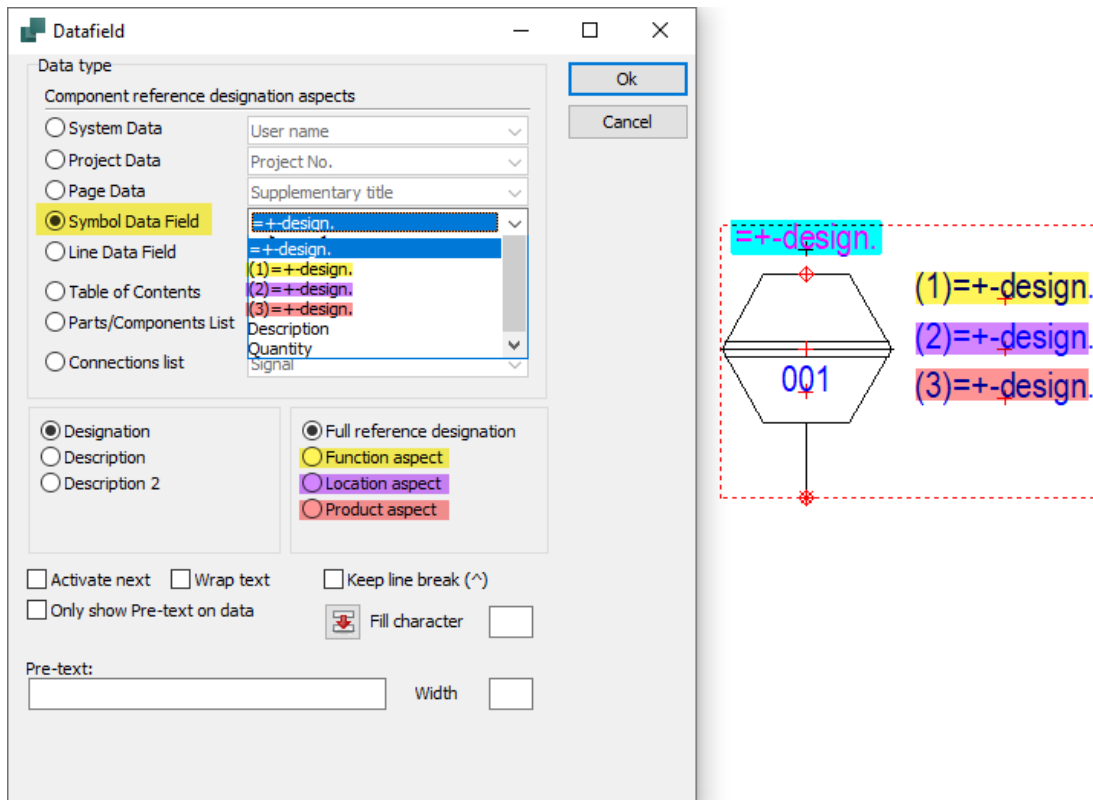

If these new symbol data fields are placed individually in a symbol, a specific aspect display (**Function aspect only**, **Location aspect only** or **Product aspect only**) can be assigned to each of them.

If such a symbol is used in a diagram, and it is assigned a complete reference designation (all aspects), then in these symbol data fields (according to the definition during symbol creation), only the individual aspect value is displayed.

Together with the available symbol data field **=+-design**. (in this example the display of the complete reference designation was defined for it), four symbol data fields are now available with which the most display requirements for aspects values of reference designations in diagram symbols can be flexible defined.

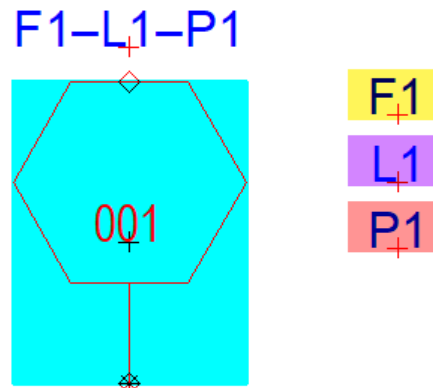
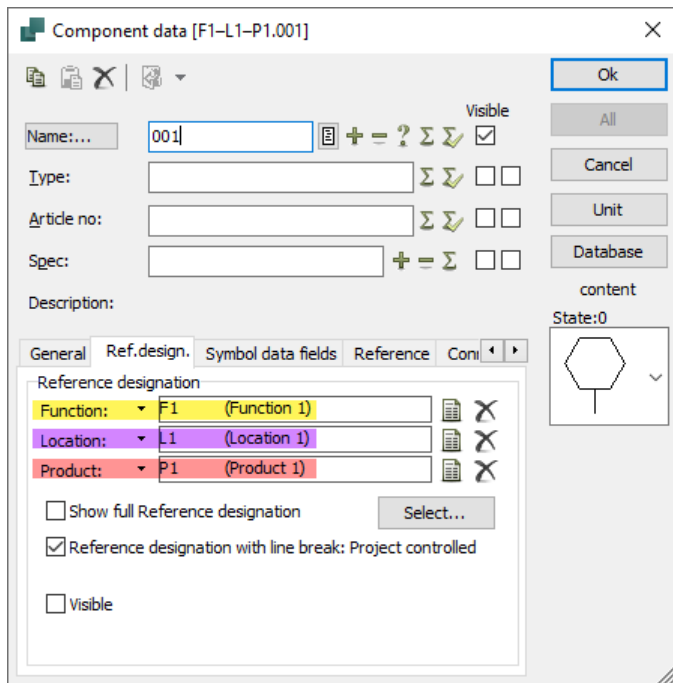

New option "Visible" for reference designations in the Name data field

In addition to the new symbol data fields, a new option has also been added for displaying the value in the **Name** (S.Name) data field.

This is only applicable when working with the reference designations, and therefore only available in the corresponding **Ref.design.** tab of the **Component data** dialog.

According to the underlying standards (e.g., IEC / EN 81346), normally the complete information of an assigned reference designation, together with the value of the component name/TAG, must be displayed on a symbol.

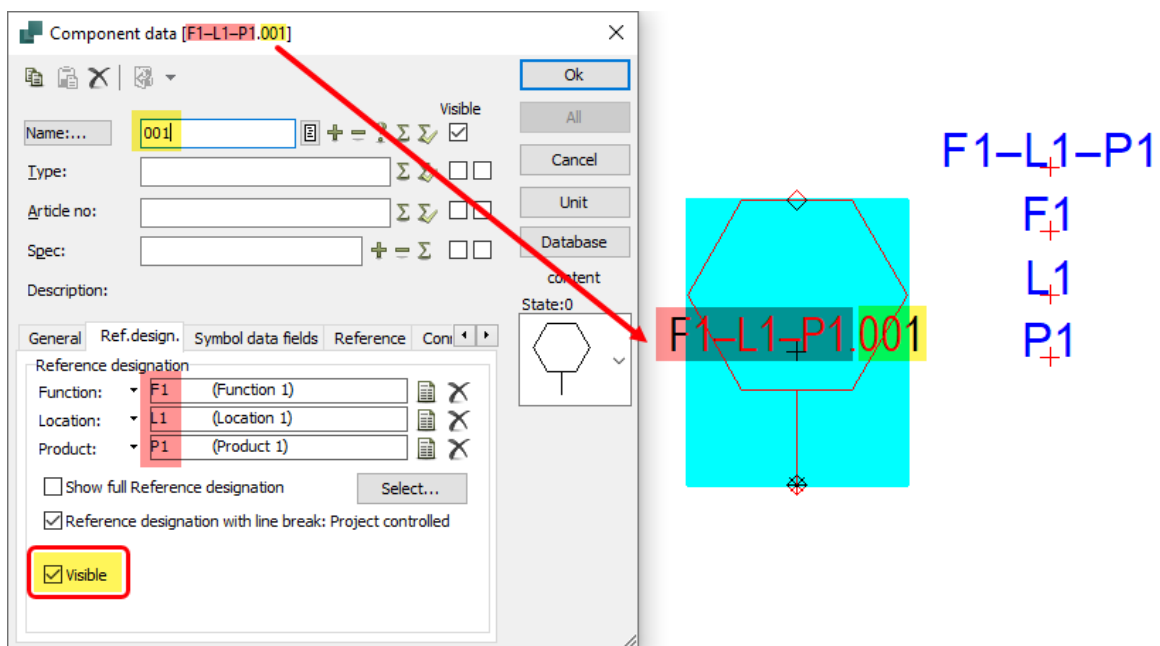

With regards to specific requirements for PCE symbols in diagrams, this standard behavior is not always purposeful.

To offer our customers and users the greatest possible flexibility when working with Smap3D P&ID, the new option **Visible** was developed.

By default, this is **active** (checked) and the display of the name including the reference designation behaves according to the above standards.

If this option is **deactivated** (unchecked) by the user, the display of the reference designation values is switched to invisible and only the **entered value** for the **Name** field is displayed at the symbol.

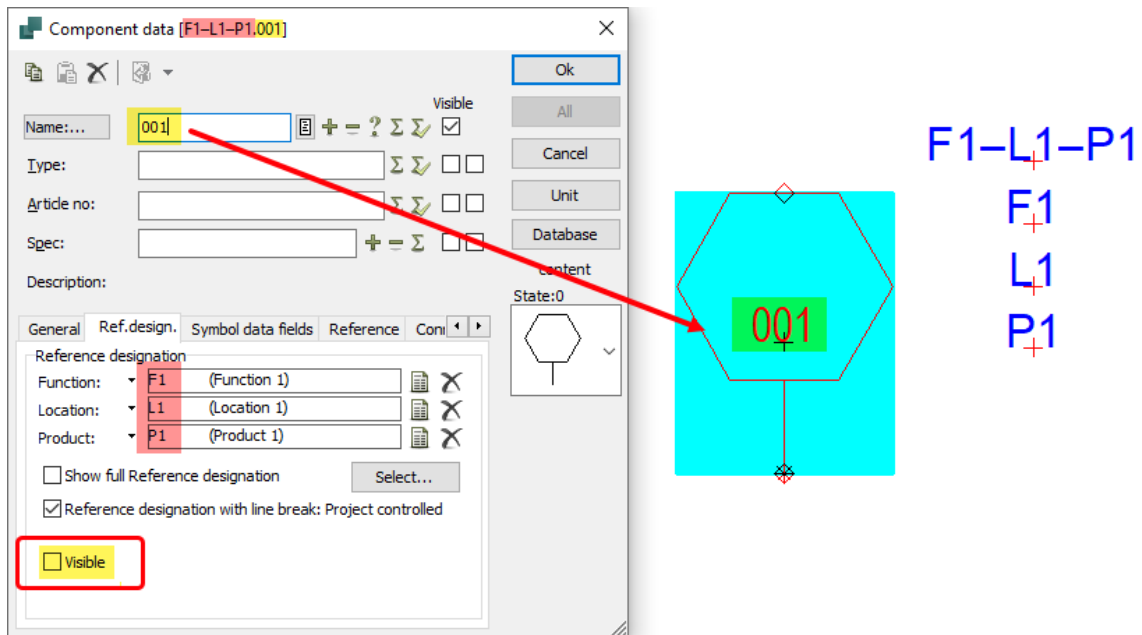

This is a pure display option (visible / not visible).

No changes are made to the assigned reference designations and their aspect values in this!!!

New, adapted PCE symbols to ISA 5.1 and EN 62424

For all customers worldwide who want to use the code letters in the PCE symbols of standards ISA 5.1 and/or EN 62424 automatically from the function aspect of a reference designation (instead of typing them in manually), we have duplicated the relevant PCE symbols from these standards, reworked them for the new handling and added them to the standard symbol library in separate new folders.

EN_62424_mm	10.12.2021 10:21
EN_62424_mm_ReferenceDesignation	15.12.2021 15:28
EN_ISO_10628-2_2012_inch	10.12.2021 10:21
EN_ISO_10628-2_2012_mm	15.12.2021 16:02
Inch_Drawings	10.12.2021 10:21
ISA_5-1_inch	10.12.2021 10:21
ISA_5-1_inch_ReferenceDesignation	15.12.2021 15:29
ISA_5-1_mm	10.12.2021 10:21
ISA_5-1_mm_ReferenceDesignation	10.12.2021 10:21

With the mentioned new functions and options, as well as these new and adapted symbols, corresponding PCE representations in diagrams can now be realized even faster and easier.

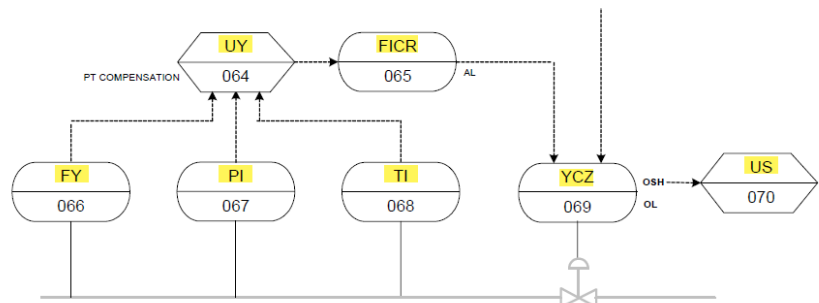
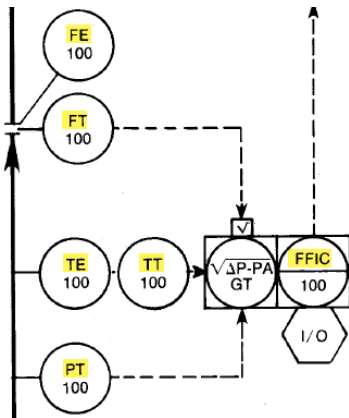

Symbol titles can be defined for all languages

To display a symbol title corresponding to the active language of the user interface, when selecting symbols in the symbol menu (F8), it is now possible to define a language-specific symbol title for each of the languages supported in Smamp3D P&ID.

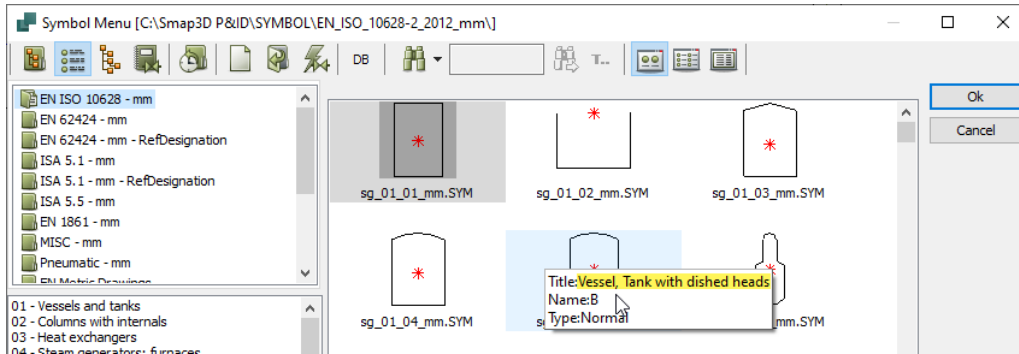

The settings for this are made in the editing mode of a symbol (symbol menu) and its symbol settings.

In the **Titles** tab, the context menu contains the **Add a language title** function.

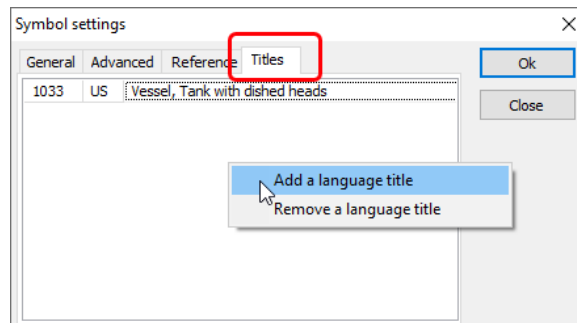

Clicking on it displays the **Select country code** dialog.

In this dialog you select the desired country code for which you want to enter a language-specific symbol title.

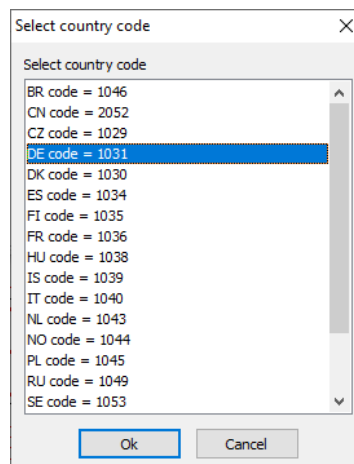

After clicking **OK**, a corresponding new line is inserted in the **Titles** tab.
According to the selected language write there the desired symbol title in the empty field.

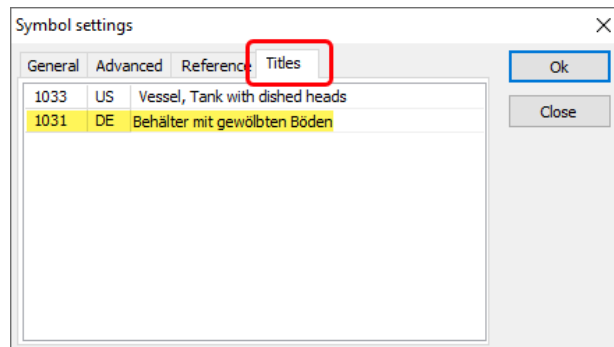

After clicking **OK**, saving, and closing the symbol editing mode, the next time you open the new symbol menu (F8), the defined title for the active language will be available.

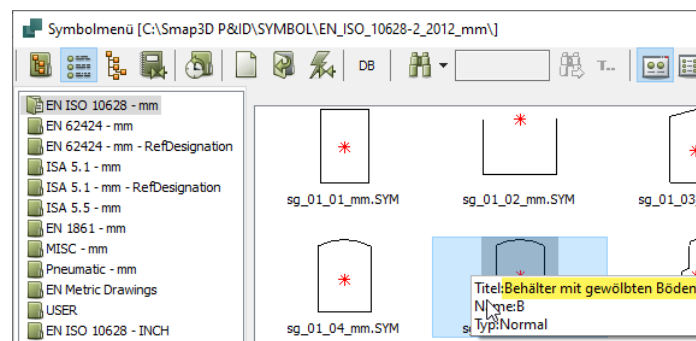

Changing the user interface language also changes country code

Until now, in Smapp3D P&ID, when switching the user interface language, this change was only stored in the configuration file **LANGUAGE.INI** in the workstation directory.

However, for the new language-specific symbol titles to work correctly, the **LanguageCode** parameter (corresponds to country code) contained in **PCSCAD.INI** is now also automatically changed accordingly when the user interface language is switched.

Smapp3D P&ID as of version 2022 must now be closed and restarted after switching the language of the user interface, since a changed PCSCAD.INI is only loaded/read when Smapp3D P&ID is started. If no restart is performed, the previous language code will be continuing to be used for the display of the symbol titles.

Symbols of EN ISO 10628 and EN 1861 with symbol title for DE and US

The existing standard symbol libraries according to the EN ISO 10628 and EN 1861 standards have been extended by us with language-specific symbol titles for the languages DE (German) and US (English - United States).

"Replace all symbols" now also updates symbol data fields

The special function **Replace all symbols** is already available since some versions in Smapp3D P&ID (menu **Functions**).

This function was developed for all customers/users where the symbols of the symbol libraries must be changed/adapted again and again to meet the current specific customer requirements.

So that such changes to the symbols of the symbol library can also be "updated back" to existing projects and diagrams, this function has been provided.

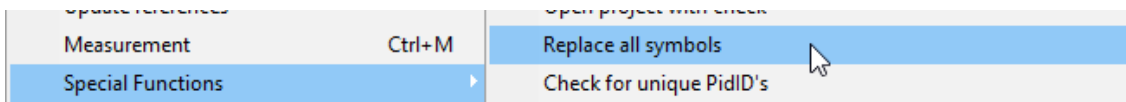

Previously, however, only symbol geometries could be updated/replaced with this, but not the symbol data fields contained in the diagram symbols.

These limitations have now been removed in P&ID 2022.

When using the **Replace all symbols** special function, for each symbol contained in diagrams it is now checked whether its symbol data field contents match to the symbol data field definitions from the library symbol of the same name.

If there are differences between an existing diagram symbol and the library symbol with the same name, this function works according to the following rules:

1. If a diagram symbol does not contain any symbol data fields, then all symbol data fields of the library symbol are transferred.
2. If a diagram symbol contains fewer symbol data fields, but these have the same name (with and/or without value) as the library symbol, the existing symbol data fields with the same name remain and only the additional/new symbol data fields from the library symbol are transferred.
Existing values are retained.
3. If a diagram symbol contains many more symbol data fields, and these only partly have the same name (with and/or without value) as the library symbol, then all symbol data fields **WITHOUT** value, which are not contained in the library symbol, are deleted.
All symbol data fields **WITH** value, which are not included in the library symbol, remain in the diagram symbol even after replacing.
All other situations or combinations of use cases, are then implemented according to the rules in **points 1 and 2**.

Command line function for special function "Replace all symbols"

To provide Smap3D P&ID users (with many existing projects and subdrawings (*.PRO files)) with even more convenience when updating symbols, the **Replace all symbols** function can now also be executed as a command line parameter.

In addition to the above enhancement for interactive execution in a single active project, this new command line feature provides the ability for automated bulk processing.

The following parameters can be called and executed in an external script or batch file.

The general command line parameters (bolt) are:

"Path to the installation directory of P&ID\and the file\PCsELcad.exe" /REPLACEALLSYMBOLS
/DRAWINGSFOLDER="Path to the folder of PRO files to be updated" /INCLUDESUBFOLDERS=ON

Here as an **example** the processing of the supplied subdrawings in a Smap3D P&ID standard installation:

"C:\Program Files\CAD-Partner\Smap3D P&ID 2022\PCsELcad.exe" /REPLACEALLSYMBOLS
/DRAWINGSFOLDER="C:\Smap3D P&ID\STANDARD\Subdrawing" /INCLUDESUBFOLDERS=ON

New "Count value" option in the "Rename symbols" functions

When placing subdrawings

If a subdrawing is placed on a diagram page by Drag'n drop, the following dialog **Rename Symbols** is displayed.

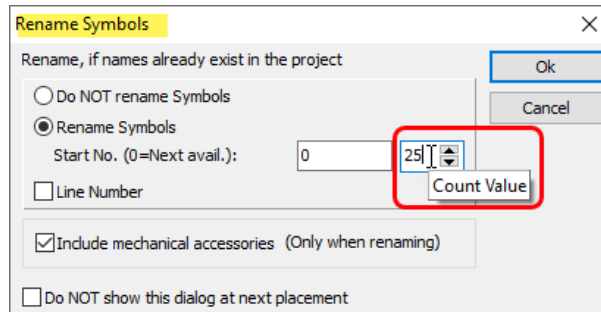

New in it is the **Count value** option.

If you enter a numerical value other than 1 in this field, the name values of the contained symbols are automatically incremented by this value for the subdrawing to be placed.

In combination with the existing **Start No.** option, it is now possible to influence the numbering of the symbols already during placement.

In the example shown, the numbers of the second subdrawing have been incremented by the count value 25, resulting in an intentional number gap from 1000 to 1025 here.

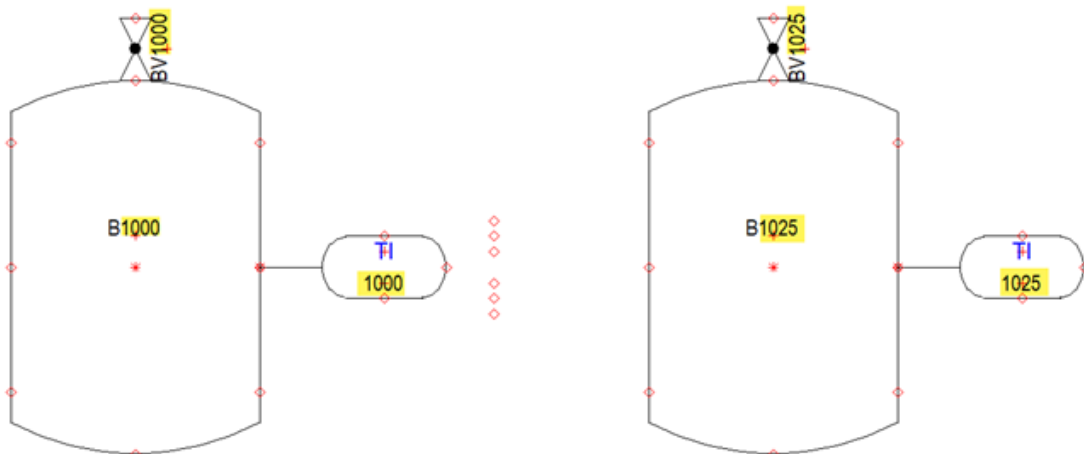

When using the "Rename symbols" module

If you have the requirement to edit the names/numbering of many already placed symbols afterwards, the **Rename symbols** has been available for this purpose since many versions. This module is started from the **Tools** menu.

Also, in it there is now the new option **Count value**.

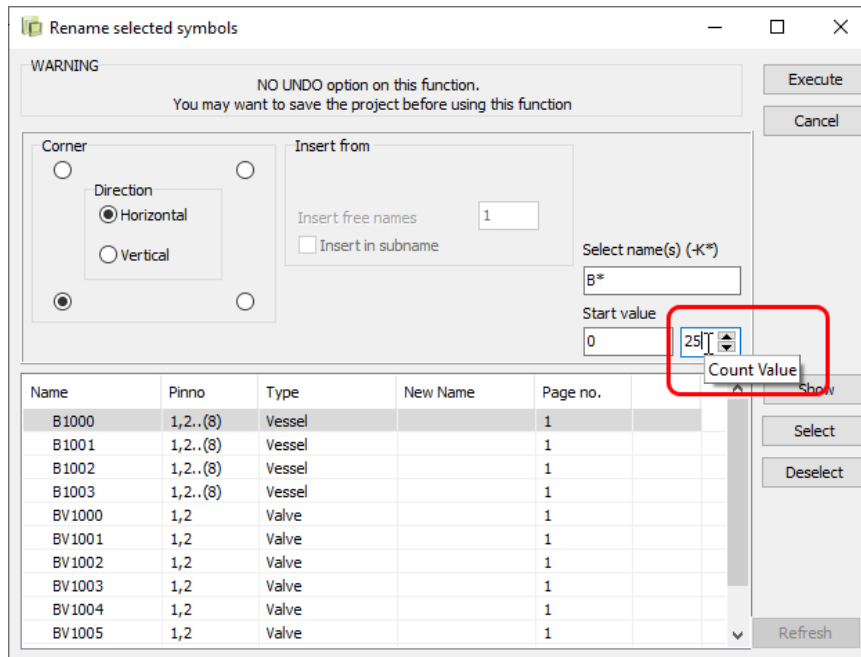

Combining all the options available in it (e.g., Select name(s), Start value and Count value), you can easily make very specific name/numbering changes for existing symbols quickly.

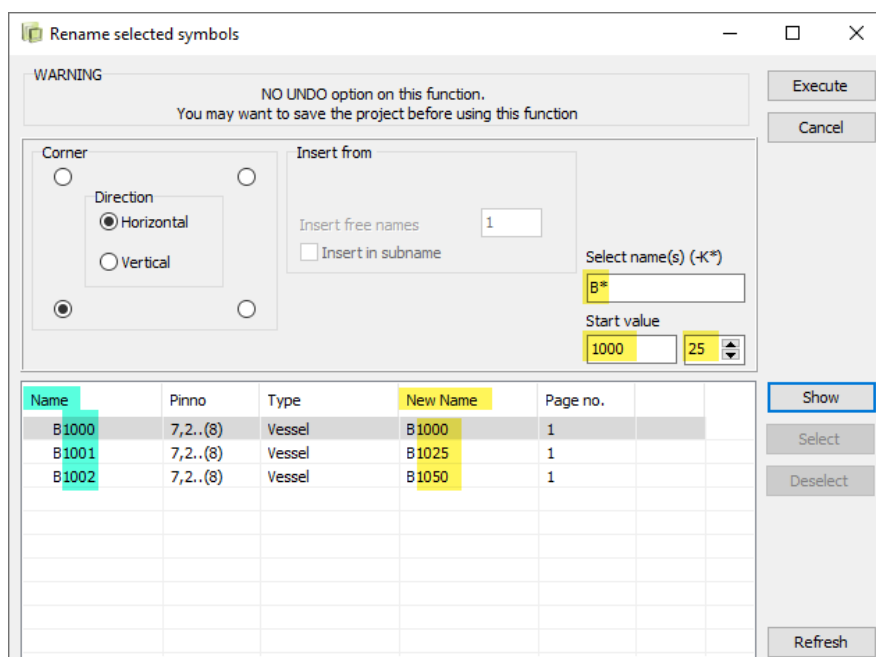

"Object data" button available directly in the Design Check dialog

When performing design checks and subsequently fixing a reported problem on the respective object (symbol, line, or connection point), an object previously always had to be selected in the diagram to then be able to call the Object data function via the main toolbar.

These ineffective mouse paths are no longer necessary as of P&ID 2022, since the **Object data** button is now included directly in the design check results dialog.

After selecting a row in the design check results, click directly on the **Object data** button in the same window.

Depending on the selected object (selected row) the corresponding dialog Component data, Line article data or Connection data opens directly.

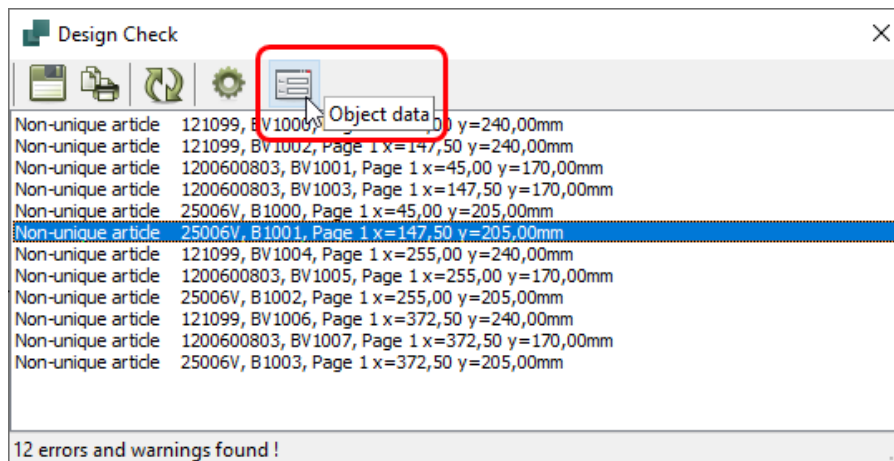

"Rename" dialog for object groups show text of previous name

For all customers who work a lot with object groups and/or subdrawings and the automatically created object groups, we have realized the following enhancement request.

Until now, after calling the **Rename** function, the input dialog **Rename object groups** for the new name was always empty.

This means that a user must always type the new name completely, even if it is only a small change or extension of the previous name.

As of P&ID 2022, the previous name of the object group is now always displayed as modifiable text in the **Rename object group** dialog, so that a user can quickly create a new name from it.

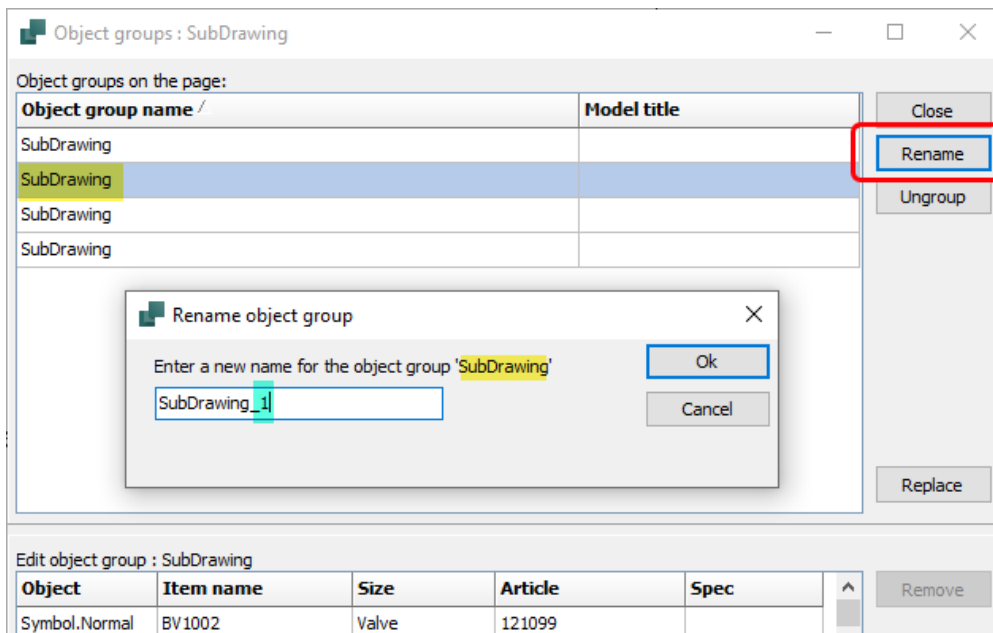

New special function "Set project start time to NOW"

For all customers who use the internal project data field **Creation date/time** or the internal page data field **Creation date/time** in the drawing borders and title blocks of their project files to display the date and/or time, there is now the new special function **Set project start time to NOW**.

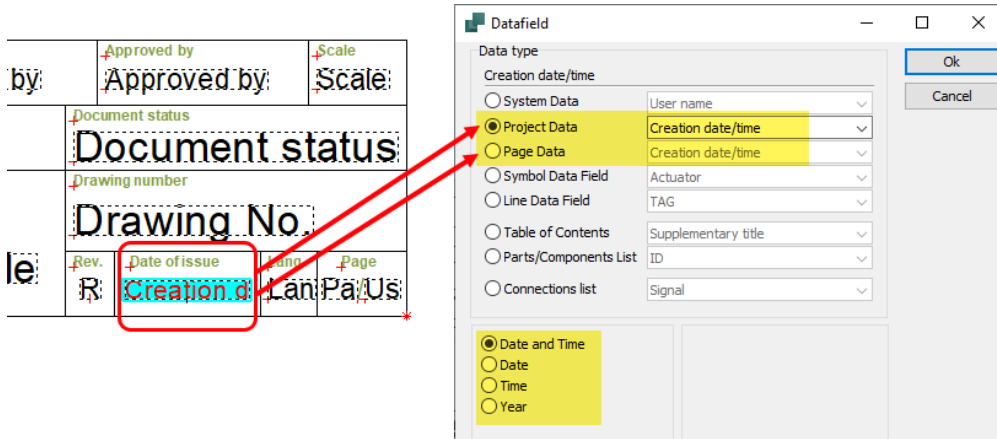

The displayed values for these internal data fields were previously only generated and automatically filled in, when a P&ID project or page was created for the first time.

This default behavior became a problem for users, whenever they wanted to use an existing P&ID project or diagram page as a base/copy for a new project and then, of course, the new/current date should be displayed in it.

To solve this in the previous versions, some manual steps were necessary.

As of P&ID 2022, such requirements for an active project can be solved with a few mouse clicks.

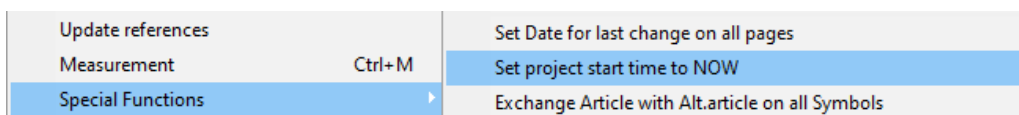

After starting the new special function **Set project start time to NOW** (in the menu Functions > Special Functions), the following dialog is displayed.

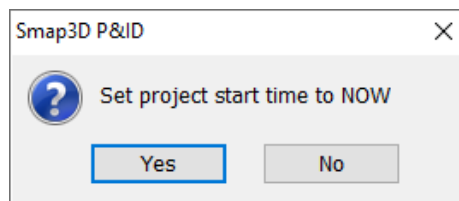

Clicking **Yes** sets the project start time for the active project file to the current date and time. According to the internal data field used (and its detailed settings), the new values will then be displayed immediately.

Default symbols and templates for drawing borders and title blocks changed

Up to now, in the standard symbols and templates we supply for drawing borders, title blocks and diagram sheets, the internal **page** data field **Creation date/time** has been used as the data field for automatically filling in the displayed date.

When used in projects, this could lead to a different date being displayed on each page, causing confusion for some customers and requests to our support.

To obtain a clear rule and a better understandable behavior of the P&ID application for all parties involved, in version 2022 all supplied standard symbols and templates for drawing borders, title blocks and diagram sheets have been reworked to **exclusive use** of the internal **project** data field **Creation date/time**.

As a result, all new projects (where these new default symbols and templates are used) will show the same date on all pages, namely the creation date of the project file.

New function "Update references" for visible data field values of formulas

Since several versions there is the possibility to control/generate certain data fields (their displayed values) via formulas.

Basically, this can be defined for symbol and line data fields.

In interaction with bulk edits of the data fields/their values on which the formulas are based (through the modules Edit symbols datafields and now also [Edit lines datafields](#)), display problems may occur immediately after a bulk edit.

In previous versions, to display these values correctly, the project had to be saved, closed, and reopened.

This was the only way to update/reload formula-driven and visible texts so far.

To eliminate the need to close and reopen in such cases, we have added the **Update references** function as of P&ID 2022 (in the **Functions** menu).

This updates all texts in a P&ID project whose visible values are controlled/generated by formulas.

New in Smapp3D Parts Management

Database Administrator displays user-defined characteristics in selection lists

This improvement will especially please those users who frequently have to enter their own standard and supplier parts into the Smapp3D 3D standard parts database so that they are available in Part Finder, the pipe specifications and Piping.

In previous versions, when categorizing and defining characteristics for new standard parts (using **Add part**, **Add parts**, **Standard Parts Assistant**, **Part Editor** and **Extend existing parts** functions), only the standard characteristics predefined by us were displayed in the selection lists for defining characteristics.

With the desired use of own characteristic definitions in own but different categories, the characteristic definitions (Name, Variable, Unit class and Unit) had to be entered and defined completely new by the user again and again.

On the one hand, this was time-consuming, but on the other hand, it was also prone to errors, since the user may not have known which detailed definitions were used for this characteristic the last time.

To now simplify this work task considerably and make it more process-reliable, as of version 2022 user-specific characteristics, if they are present in the database because of parts already registered in the database, will also be displayed in **all relevant selection lists** for characteristic definitions. A user can now conveniently fall back on the same user-defined characteristic definitions whenever new parts need to be registered in the database, or existing ones need to be changed in their categorization and characteristic definition.

In the example shown, specific part in the **New** category with the user-defined characteristics **Test 1** and **Test 2** were registered into the database at an earlier time.

If new parts are now defined for a new and different category (e.g., New category 1) later, the user-defined characteristics are included in the associated selection list and can be easily selected.

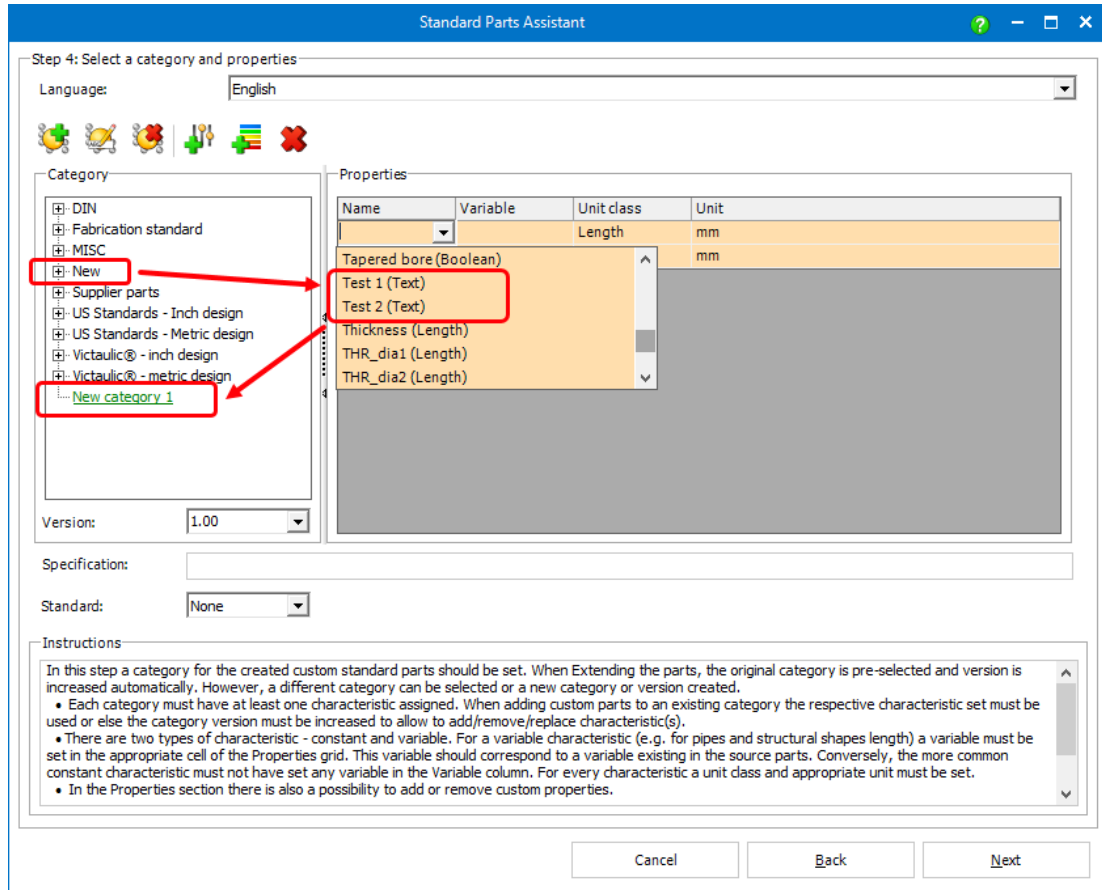

New in Component Wizard

New component types with adapted preparation steps

After implementing new automations (QuickPlace methods) for various components in Smapp3D Piping in previous versions, we have added three of these new component types in the Component Wizard as guided step-by-step preparation for the 3D parts intended for them.

The first new component type is called **Grooved coupling**. After this selection, it is necessary to choose in the corresponding list box between the customized preparation procedure for a **Grooved coupling requesting part**, or a separate one for a **Grooved coupling part**.

Details on the associated and existing automatisms can be found in the [online help](#).

The second new component type is called **Tri-Clamp**. After this selection, a further selection must also be made in the associated list box. Here we offer a preparation workflow for a **Tri-Clamp gasket**, as well as a separate one for a **Tri-Clamp part**.

Details on the associated and existing automatisms can be found in the [online help](#).

The third new component type is called **Welding nipple**. There are no further selection options for this one.

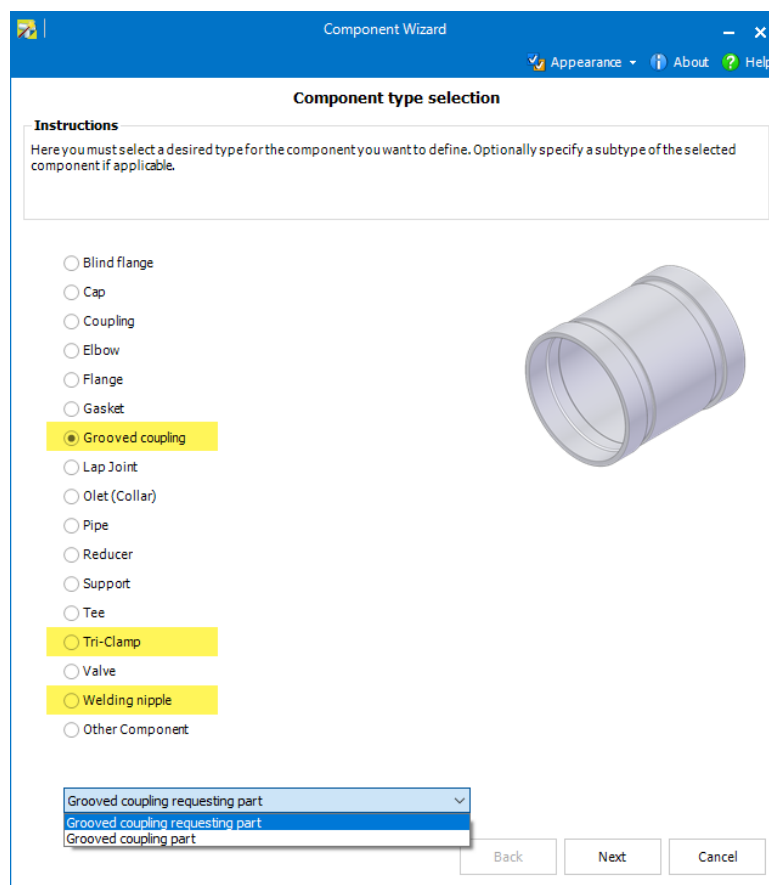

We have made an extension to the **Coupling** component type. In the corresponding list field, an adapted preparation workflow is now also available for a **Coupling requesting part**, or a separate one for a **Coupling part**.

Details on the associated and existing automatism can be found in the [online help](#).

Last used part provider preselected

In the **Save component** step of the Component Wizard, a user must select the desired Part Provider with which to manage the prepared 3D part.

Here, since several versions, there is a choice between **File System Provider** and **Preselected Standard Parts Provider** (normally Part Finder).

Previously, a user had to make the selection in this step each time.

As of version 2022, the last selection used in this step is now saved (in the Windows User profile) and used when preparing a next part.

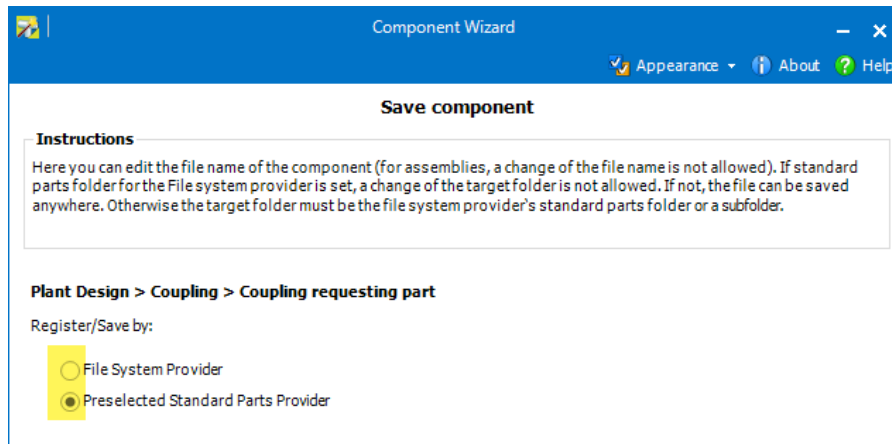

New in Smap3D Piping

In Basic engineering mode the generation of concentric reducers is possible

Since the introduction of the optional **Basic engineering mode**, many users have tested this mode and found its advantage to be a very positive option for their workflows with Smap3D Piping. However, many users missed the possibility to reduce pipe runs already in basic engineering mode or to use the existing functions **Place one concentric reducer** and **Place concentric reducer twice**.

We have removed this limitation in the 2022 version.

The well-known functions **Place one concentric reducer** and **Place concentric reducer twice** can now already be executed and used in basic engineering mode with the same basic rules as in detail engineering mode.

As result in basic engineering mode, only basic pipes and pipe paths are divided and modified accordingly, reducer fittings are not placed at this time.



Only when switching to the detail engineering mode later, all previously designed situations in a pipeline, with selected pipe specification are generated completely and in detail.



New function "Switch all to detail engineering"

A comfortable and automated switching from basic to detail engineering mode for multiple pipeline assemblies at the same time was also requested in customer feedback.

Previously, this could only be started in an active pipeline assembly for the pipeline paths it contained, via the Piping context menu.

As of Piping 2022, the new **Switch all to detail engineering** function is available for this requirement.

This function is in the drop-down list of the existing **Refresh all** button.

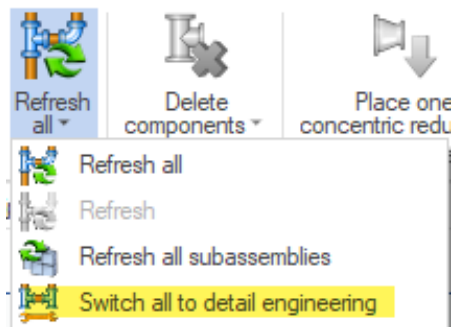

After starting this function in the top assembly level, the corresponding selection dialog is displayed.

All subassemblies declared as pipeline assemblies are listed here.

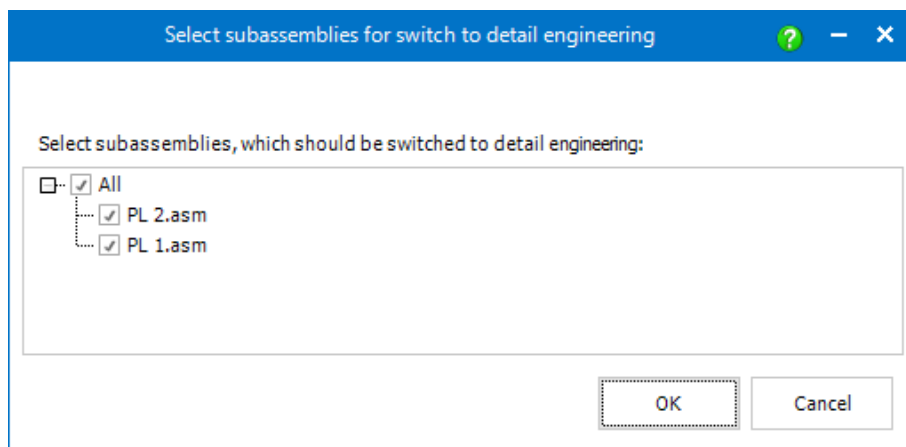

After an appropriate selection by the user and click on **OK**, the automatic switching from basic to detail engineering mode starts.

Any problems and error messages that may occur during switching and detailed generation of the individual pipelines are collected by the program.

After the function is completed, a corresponding **report window** is displayed.
If there are entries in it, the user must check them for the pipeline assembly and correct them accordingly.

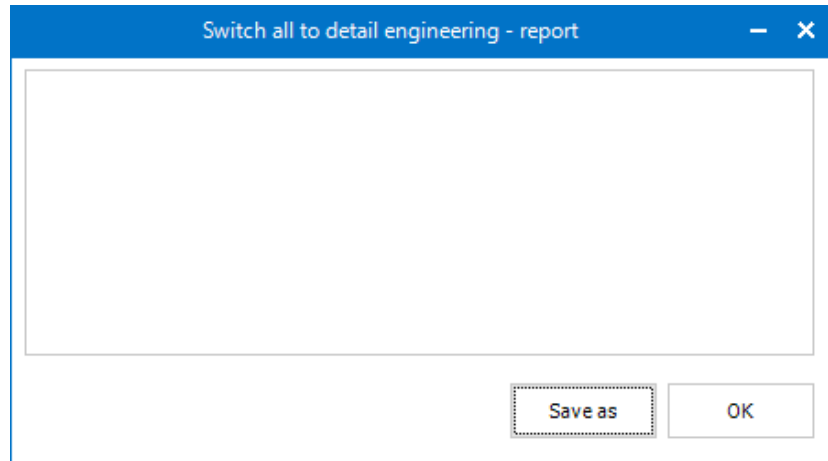

"Finish and save" function now configurable

Since many versions the function **Finish and save** is available in Smapp3D Piping. This was developed to be able to perform various individual functions automatically with just one mouse click at the end of a pipeline creation in an active pipeline assembly.

Previously, **Finish and save** automatically performed all subsequent steps in the active pipeline assembly:

- **Refresh all** - all the generated pipelines are refreshed.
- **Show all components** - all fittings, pipes and insulations are set to be visible.
- **Set all pipes and insulations selectable** - all pipes and insulations are set to be **selectable** within the CAD working window.
- **Hide all pipeline paths** - all pipeline paths are set to be invisible.
- **Hide all Piping 3D sketches** - all the Piping 3D sketches get hidden in the active assembly.
- **Save** - the active assembly document is saved.
- **Exit** - Smapp3D Piping terminates.

However, since not all customers need all steps of this previously hard-coded function for their workflow, we have created a configuration option for this function from version 2022.

After installing Plant Design 2022, the **FinishAndSaveOptions.xml** file is now located in the configuration folder.

This XML file can be opened with a common editor program.

This lists the above-mentioned individual functions, each with a configuration parameter.

If the parameter is **true**, the single function is executed as part of **Finish and save**.

If the parameter is **false**, it will not be executed.

```
1 <?xml version="1.0" encoding="utf-8"?>
2 <clsFinishAndSaveOptions xmlns:xsd="http://www.w3.org/2001/XMLSchema" xmlns:xsi="http://www.w3.org/2001/XMLSchema-instance">
3   <RefreshAllPipelines>true</RefreshAllPipelines>
4   <ShowAllComponents>true</ShowAllComponents>
5   <SetAllPipesAndInsulationsSelectable>true</SetAllPipesAndInsulationsSelectable>
6   <HideAllPipelinePaths>true</HideAllPipelinePaths>
7   <HideAllPiping3DSketches>>false</HideAllPiping3DSketches>
8   <SaveOpenedAssembly>true</SaveOpenedAssembly>
9   <ClosePiping>false</ClosePiping>
10 </clsFinishAndSaveOptions>
```

Place split point for Isometric now also with fittings

The existing **Place split point for Isometric** function has been extended to allow placement of internal component **Iso_split_point.par** now also on fittings. Previously, this function could only be applied to selected pipe files.

If you now select a fitting file and start this function, a new dialog appears. In it, a user must use the **Arrow button** to select the desired coordinate system on the fitting (highlighted by red ball) to which the internal iso split component should be placed. With **Ok** (green check mark) the function is completed, and the internal component is placed at this position.

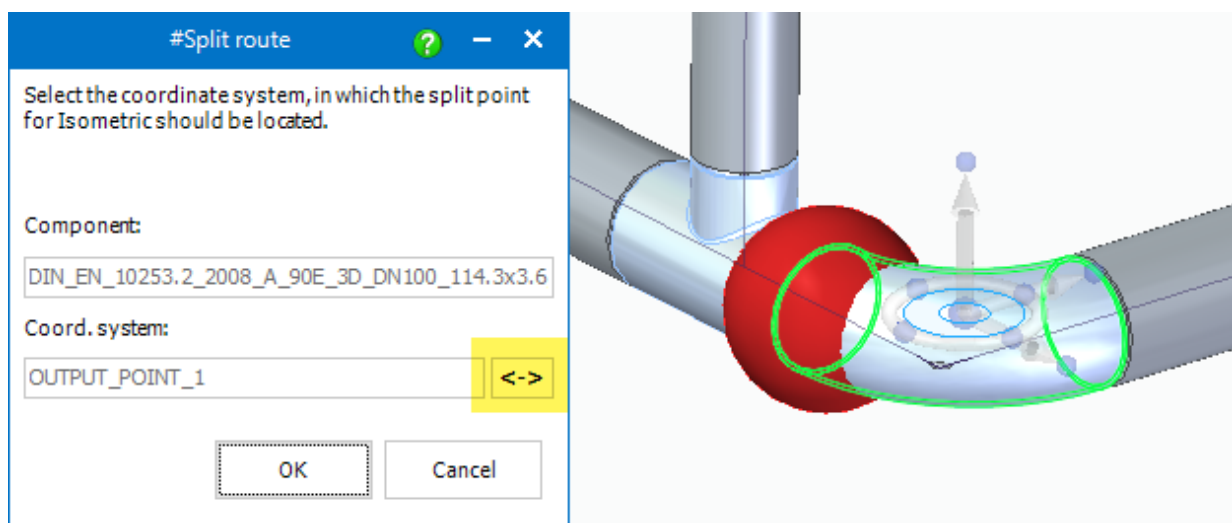

Function "Update all custom occurrence properties" now also in "Refresh all subassemblies"

For all customers who have set their system configuration to write/update Smapp3D Plant Design virtual characteristics/attributes to Solid Edge custom occurrence properties, we have now realized another improvement.

Previously, this update/write to custom occurrence properties was only done when actively working with the To-Do list or the Virtual Characteristics Writer.

A subsequent update was available to the user only for an actively opened pipeline subassembly, through the function of the same name in the context menu of Piping.

For more convenience and time saving, the **Update all custom occurrence properties** function is now also integrated into the **Refresh all subassemblies** command.

This means that this update can now be started in a kind of bulk process from the main assembly, without a user having to do this actively in each individual pipeline assembly.

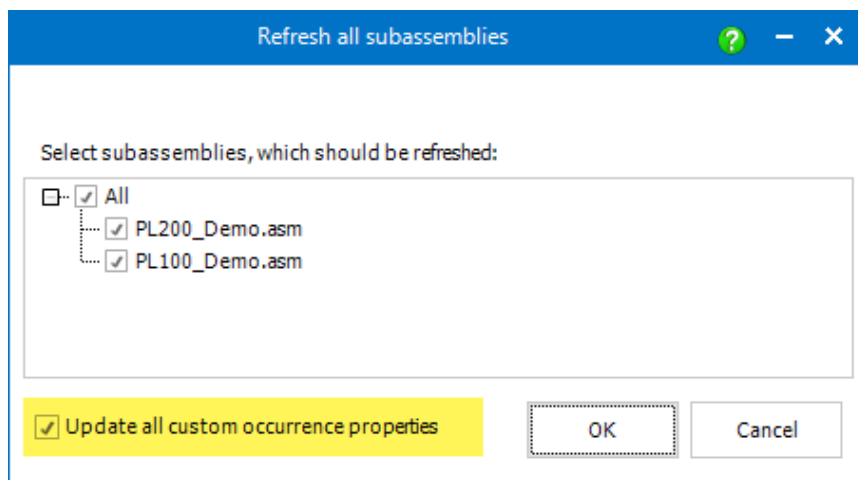

Design Check "CS Info" only checks the numerical values

When running the **CSInfo design check** (for checking the CS Info parameters Size, Wall thickness and Outer diameter), the complete string from CS Info property of the 3D files to be compared has always been used so far.

This led to error messages in the design check results in situations of different spelling and/or different text-number combinations (e.g., **DN 50** and **DN50** or **50**), but these were not really design errors.

As of version 2022, we have changed these check routines to that only the numerical values contained in the respective CS Info definition are used for the check.

This means that error messages are now only reported in the design check results if the files to be checked really contain different numerical values.

This then actually suggests different and incompatible 3D components.

Pipe Specification Editor allows copying rows to key name "Union"

For the key name **Union**, the definitions of the subentries (Flange, Counterflange, Gasket and Lap Joint) had to be defined individually and selected from the Part Provider.

However, customers often wanted to use the same definitions and parts in these subentries, that they had previously made for the main key names Flange, Counterflange, Gasket and Lap Joint.

To make this faster and more comfortable for the users, now already completely defined rows can be copied (Copy rows) and pasted into the subentries of key name **Union** (Paste rows).

Virtual characteristics (e.g., Additional Items) already defined at the source row, are transferred as well.

Technically, this also makes it possible to copy the subentries from the **Union** key name to create them as the main key names in the pipe specification.



New in the P&ID to 3D connection (P&ID To-Do list)

P&ID component ID is now used as unique identifier

Until now, only the **Name** defined in the P&ID file for a symbol was used and stored in the P&ID To-Do list as a unique identifier for the assignment to a 3D file.

When changing this name in the P&ID symbol, this led to the fact that after refreshing the To-Do list, a 3D file already assigned with it was displayed in the status **Deleted** (red icon), as well as the renamed symbol was displayed as new component (orange icon).

To handle such situations in a fundamentally better way, the new internal symbol property **Component ID** has been introduced in the P&ID application.

The value of the component ID is an internal numerical value and is automatically generated when placing a symbol in a project/diagram page.

Unlike **Name**, the value of the **Component ID** cannot be changed by a user.

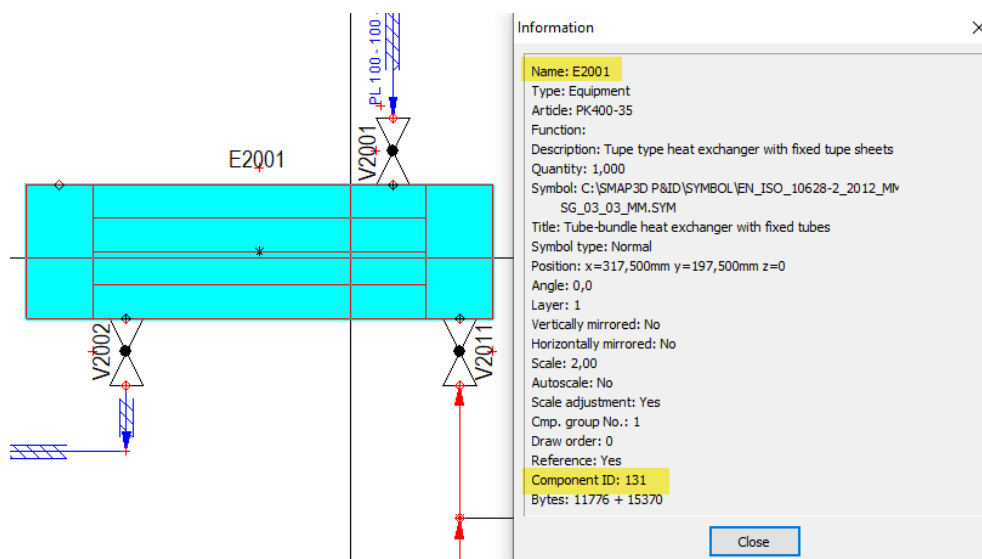

As of version 2022, only the value of this P&ID component ID is used as a unique identifier for all component assignments from the To-Do list to 3D files.

This means that name changes to symbols in P&ID, in the To-Do list with already assigned 3D files will no longer lead to the status **Deleted**.

Instead, this now leads to the **Out-of-Date** status (yellow icon), which can be quickly updated again using the existing **Update Info in CAD** function.

All customers who also use **Smapp3D Isometric** and have used the virtual property **PID_C_Name** for the transfer of the symbol name/TAG number to the isometric drawing, must now make changes in their existing Isometric options, in the output mappings of properties.

The same applies to customers who transfer the virtual characteristics of Smapp3D, to a user defined occurrence property in CAD.

From version 2022 on, the virtual property **PID_C_Name** will contain/transmit only the numerical value of the component ID.

New virtual characteristic "PID_C_DisplayName"

However, since the symbol name/TAG number from P&ID is of course still important for subsequent processes (e.g., isometric creation with Smapp3D Isometric, or the transfer of the virtual characteristics into user-defined occurrence properties of the CAD), a new virtual characteristic with name **PID_C_DisplayName** was introduced for this purpose.

From now on, the **Name** defined at the P&ID symbol is transferred as the value of this virtual characteristic for all subsequent process steps and applications.

The screenshot displays the 'Information' window for a valve symbol 'BV2011' and the 'Feature' table for its CAD component. Red boxes and arrows highlight the mapping of the symbol name and component ID to the new virtual characteristics.

Feature	Value	Source
#PartID	PartFinderJd69a8d421c824ba94bdf52d59f679	Occurrence attribute
#PartNo	220150100291	Custom property
#PID_C_Article	220150100291	Occurrence attribute
#PID_C_DisplayName	BV2011	Occurrence attribute
#PID_C_EquipmentType	Inner	Occurrence attribute
#PID_C_Name	139	Occurrence attribute
#PID_C_OBJECT GROUPS	PL 240	Occurrence attribute
#PID_C_SymbolType	Normal	Occurrence attribute
#PID_C_Type	Valve	Occurrence attribute
#PID_DB_ACTUATION	Notch lever	Occurrence attribute
#PID_DB_APPROVED	False	Occurrence attribute

New configuration options for displaying aspects of reference designations

If the reference designations are used in P&ID files and assigned to the symbols, then according to the underlying standards, these reference designations are always displayed as part of the name.

In the Smapp3D P&ID application, there have long been various options for configuring the display of the reference designation, or even just individual aspects, for customer-specific display requirements on a diagram.

In the P&ID To-Do list, such a configuration was not possible until now.

Here, all defined values of a reference designation were always displayed also as part of the components name.

In this context, the full name (incl. complete reference designation) was also passed on as a name/TAG number when assigned to the 3D file.

When creating isometrics, this then of course also leads to these complete TAG numbers, which is not desired by some customers at this point.

P&ID To-Do list			
Name	Ref. function	Ref. location	Ref. product
Component <input checked="" type="checkbox"/>			
<input checked="" type="checkbox"/> =F1/+L1/-P1 PUMPE 1	=F1	+L1	-P1

To provide more flexibility to our customers with such specific display requirements, we have added new configuration options to the **P&ID To-Do List Options**.

Users can now choose which aspects (their values) of a P&ID symbol with assigned reference designation, should be used in the To-Do list as part of the name and thus also as part of the virtual property **PID C DisplayName**.

By default, all aspects are enabled (with a check mark), which corresponds to the previous way of working and the previous result.

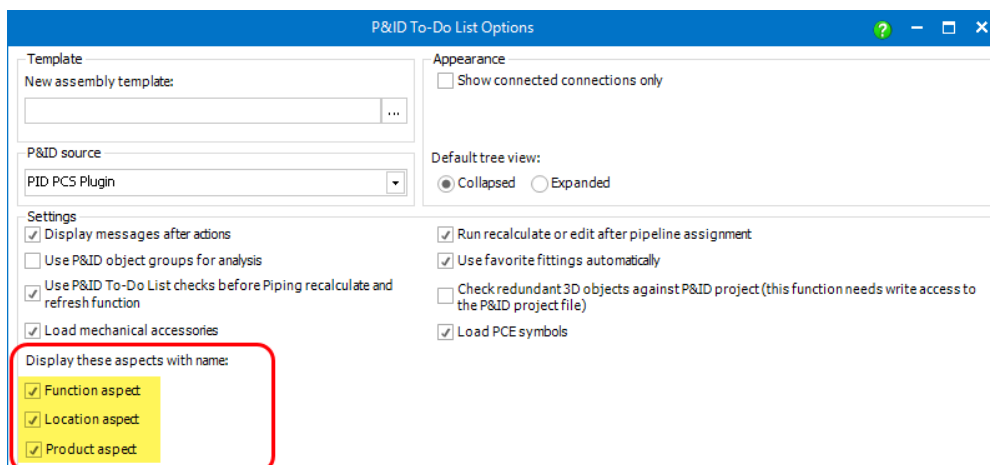

If individual aspects are deselected (no check mark), only the selected aspects (their values) will be displayed as part of the name after reloading with **Refresh from PID project** command.

When assigned to a 3D file, only the value shown here is then written as virtual characteristic PID_C DisplayName.

P&ID To-Do list			
Name	Ref. function	Ref. location	Ref. product
<input type="checkbox"/> Component <input checked="" type="checkbox"/>			
<input checked="" type="checkbox"/> =F1/-PUMPE 1	=F1	+L1	-P1

To-Do list sort reductions after inner equipment

Previously, reducers from a P&ID file were handled as normal inner equipment but displayed with a special symbol. This meant that when sorting/ordering in the To-Do list structure tree, all inner equipment was sorted alphanumerically by name.

Depending on the naming of the reducers and the other symbols, this could lead to a mixed representation of valves/armatures and reducers in the To-Do list.

As of version 2022, existing reducer symbols are distinguished from the inner equipment (defined in the P&ID by symbol type Reduction) and always displayed below the inner equipment in the To-Do list.

This improves the overview in the To-Do list.

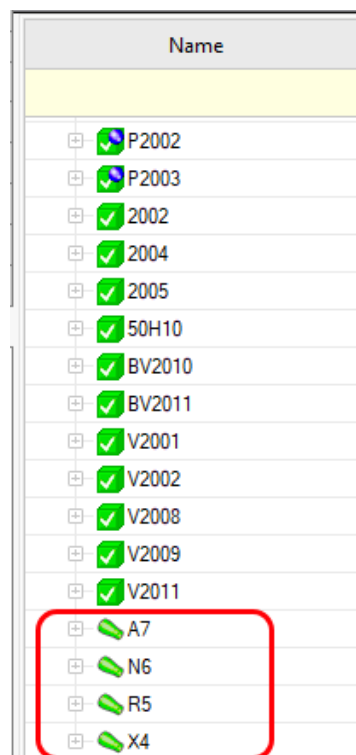

Name	
+	P2002
+	P2003
+	✓ 2002
+	✓ 2004
+	✓ 2005
+	✓ 50H10
+	✓ BV2010
+	✓ BV2011
+	✓ V2001
+	✓ V2002
+	✓ V2008
+	✓ V2009
+	✓ V2011
+	✓ A7
+	✓ N6
+	✓ R5
+	✓ X4

Enhanced option "Run recalculate or edit after pipeline assignment"

Previously, this option was called Run recalculate after pipeline assignment.

Therefore, only the recalculate pipeline function was executed after pipeline assignment. This was correct and sufficient for all situations in which 3D pipelines were planned directly with the To-Do list and on whose pipeline paths no pipeline was generated yet.

However, more and more customers are now also linking existing, possibly older pipeline assemblies (only created with Piping), via the To-Do list with P&ID projects/diagrams. It is possible that changes have occurred between the original pipeline generation and the current P&ID planning regarding the pipe specifications or contents to be used.

To nevertheless obtain a correctly generated 3D pipeline in cases after assignment from the To-Do list, it was necessary to extend the existing function.

As of version 2022, this option has been renamed to **Run recalculated or edit after pipeline assignment** and functionally expanded.

Now, after a pipeline assignment, the To-Do list checks each time whether pipeline objects are already placed on the selected pipeline path.

- If only the pipeline path exists without placed pipeline objects (fittings and pipes), the **Recalculate pipeline** function is executed as before. This function recalculates the pipeline with the assigned pipe specification and places all missing fittings and pipes.
- If pipeline objects (fittings or pipes) already exist on an assigned pipeline path, the **Edit pipeline** function is executed. This first deletes all existing fittings automatically placed by Piping, and then repositions the current fittings of the pipe specification assigned by To-Do list. The existing pipes are edited to match the pipes of current pipe specification geometrically and informatively. For existing and manually placed objects, an attempt is made to replace them with contents of the current pipe specification based on the key names.

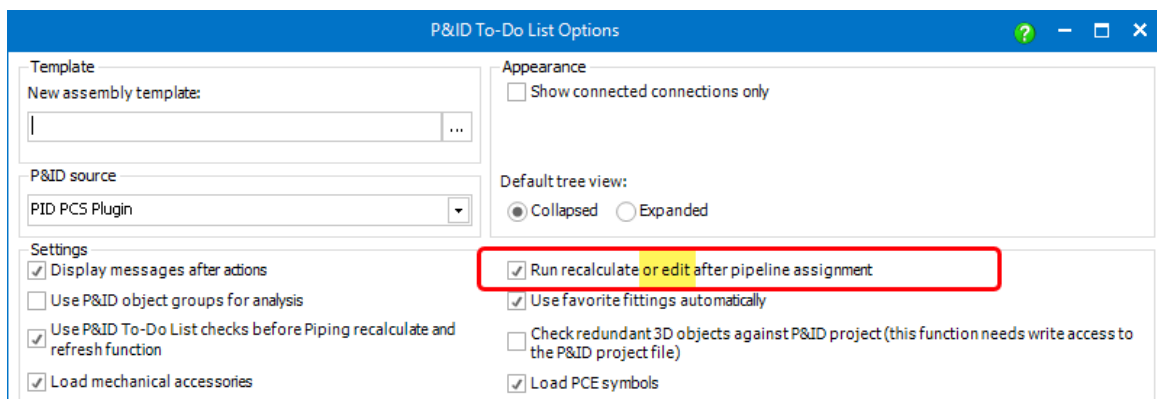

Function "Place 3D model to CAD" can use P&ID database entries PartProvider and PartID

To be able to place the associated 3D file directly from a To-Do list entry using **Place 3D model to CAD** function without any further selection steps, two definition options were previously available:

- Definition of the **P&ID ID** (article number from P&ID database) to the row of the 3D file in the pipe specification
- Definition of the physical location (path) of the associated 3D file in the P&ID database, in the **PathToModel** database field

Starting with version 2022, we provide a third definition option.

If a 3D file is registered in the active 3D standard parts management (by default this is the Part Finder of the Smapp3D Parts Management), the **PartProvider** name as well as the **PartID** of this 3D file can be defined for an article/component in the P&ID database.

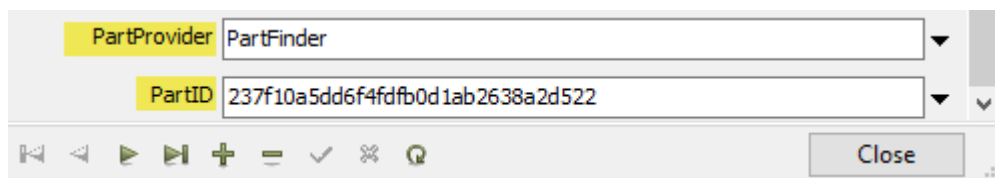

If a component (with this predefinition in the P&ID database) is then listed in the To-Do list and the function **Place 3D model to CAD** is executed for it, the 3D file is placed in CAD through automatic internal communication between the To-Do list and the Part Provider, without any further selection steps.

Of course, this internal communication also works for other Part Providers, e.g., for customers who have an individual integration/connection to a PDM or ERP system in use.

New in Smapp3D Isometric

New interface for "post-process plugins"

More and more customers have the requirement for their internal processes and workflows to automatically perform specific tasks with these output files generated by Isogen© after the generation of the isometric drawings, as well as any separate reports.

As an example, here are two of the requests we received:

- automatic transfer of report files in CSV format to a specific ERP system.
- automatic conversion of drawing files into specific file formats for long-term archiving.
- and others.

Since the very most of these requirements are customer-specific, it does not make sense for us, to implement them into the software as standard functions for everyone.

However, to provide the general technical base for solving/implementing such specific requirements, we have developed and implemented a standard interface for **post-process plugins** in Smapp3D Isometric 2022.

In **Isometric Options**, in the **Advanced** tab, there is now the **Post-process plugins** section. By default, there are NO entries in it.

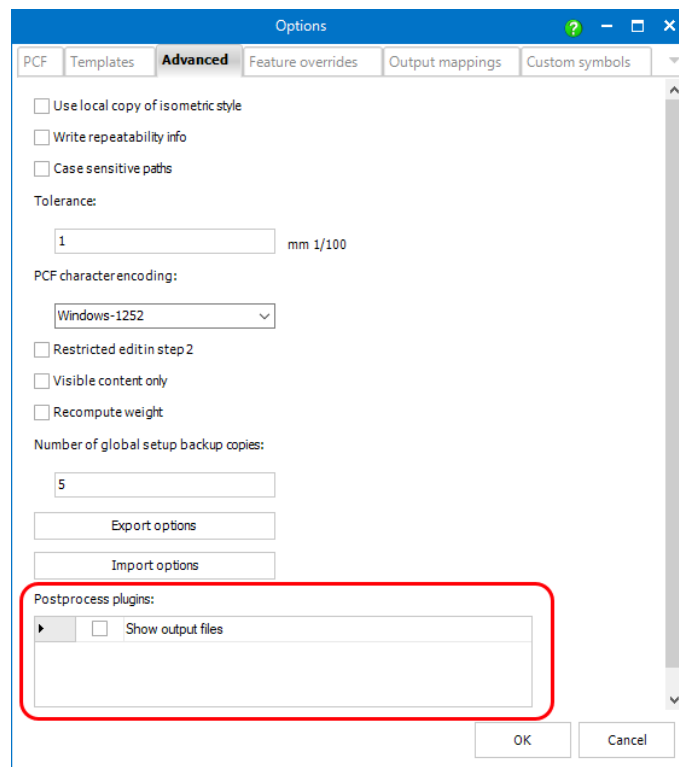

To get existing post-process plugins displayed in it and to be able to activate them here, the corresponding plugin files (*.DLL) must be contained in the standard plugins directory of a Smap3D Plant Design installation.

Default path to this directory is: *C:\Program Files\CAD-Partner\Smapp3D Plant Design 2022\Plugins*



With each client installation of Smap3D Plant Design 2022, we provide a **compiled plugin as example** (Isometric.PostprocessShowFiles.dll).

Read and follow the included **Readme.txt** to put this sample plugin into operation if needed.

Since this new **post-process plugin** interface can only work with plugins that meet our programming requirements, we also provide a **Visual Studio C# project as a template and description for programmers**. This should enable experienced programmers to quickly develop their own post-process plugins for this interface.

Both are in the custom directory after each Plant Design 2022 installation.

Default path to this directory is: *C:\Program Files\CAD-Partner\Smapp3D Plant Design 2022\Custom*

 Isometric.PostprocessShowFiles	10.12.2021 10:24
 Isometric.PostprocessTemplate	10.12.2021 10:24

New interface for using external scripts in Feature overrides

For the automatic processing and calculation of **property values from CAD source files**, before passing them to Isogen©, the functions for **Feature overrides** have been available in Smapp3D Isometric for many versions (Isometric options, in the **Feature overrides** tab). It already offers very powerful and extensive editing options with the **Formula editor**.

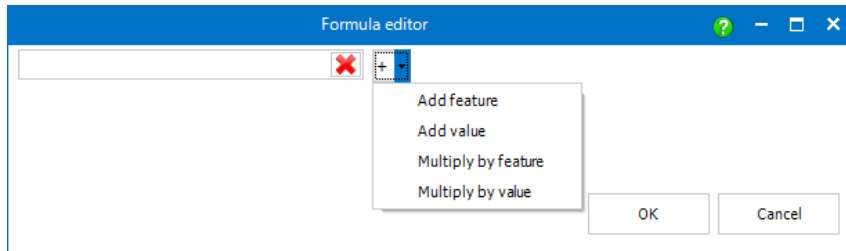

However, to support our customers with extended and very individual requirements even with this set of functions, we have developed and implemented a new interface for the use of feature overrides plugins for external script languages (e.g., Python) for this purpose.

The definition of the feature overrides plugins (which external script language with which script function), is done in the **Isometric options** in **Feature overrides** tab.

Here, in addition to the formula editor, the button for a **plugin selection** is now available for each line.

Priority	Feature name	New value		Filter feature	Filter value	Component role
10	Component Type	ELBOW		Part Type	2.1.7	Pipe
10	CATEGORY	ERECTION		Component Type	BOLT	All
10	CATEGORY	ERECTION		Component Type	GASKET	All
15	CATEGORY	{ISO_CATEGORY}		ISO_CATEGORY		All
0						

After clicking this button, the **Plugin select** dialog opens for the selected line.

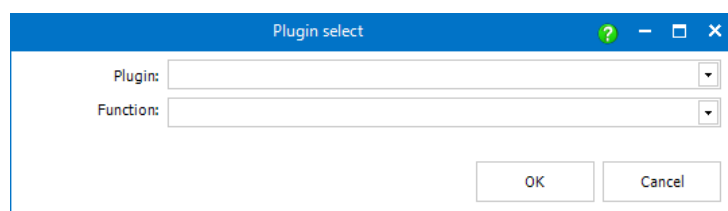

If the desired feature overrides plugins with associated script language are correctly installed and configured on the active computer, they will be listed in the **Plugin** list box. After selecting a plugin, the associated functions are listed in **Function** list box.

With this new interface, it is possible to specify a custom script/function for each row in the **Feature overrides** tab.

For the feature override plugins defined in **Feature overrides** tab and their function to be applied by Smapp3D Isometric during isometric creation, this must be activated in the **Isometric options**, in **Advanced** tab, with the new option **Run feature override plugins**.

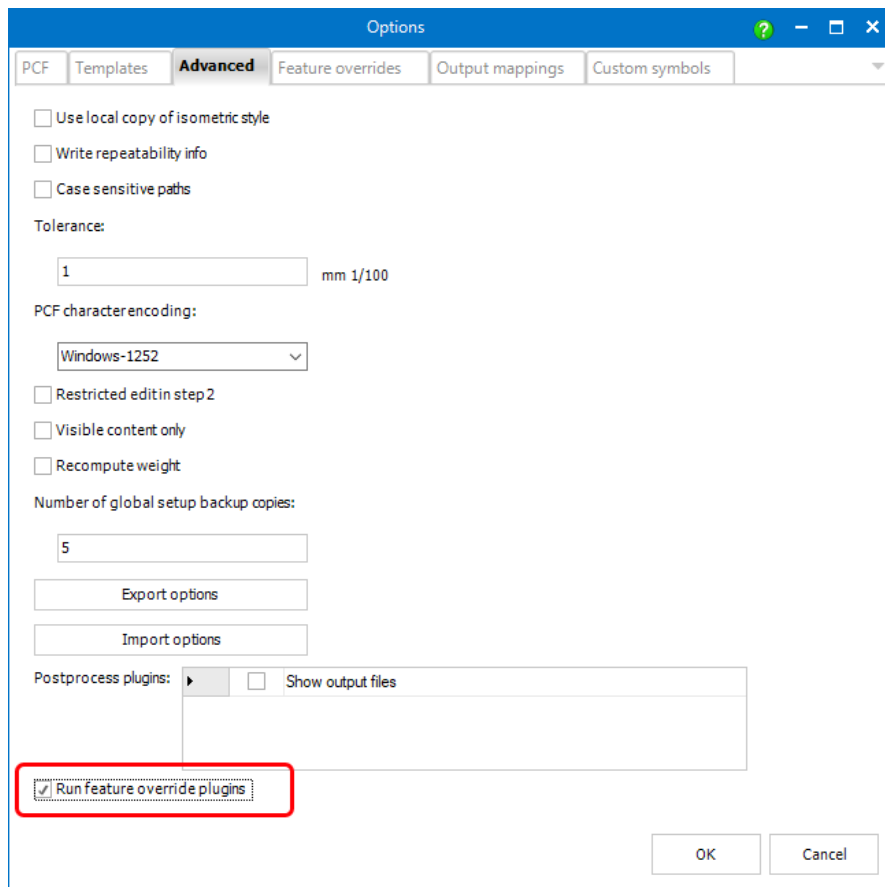

If all the necessary settings for feature override plugins in Isometric options are done correctly, the processing results of the external scripts will be displayed immediately in **Isometric Step 2 - Data validation** for the corresponding content.

This behaves identically to the previous edits with the formula editor.

However, feature override plugins and their external scripts may take longer to calculate, depending on the size and functions of the scripts to be executed. In these cases, a progress bar is displayed.

Standard feature override plugin for "Python script language"

Generally, the new interface for feature override plugins described above is a universal interface without pre-definitions for a specific programming and/or script language. Customers and their programmers can develop a plugin for any scripting language with the appropriate know-how, depending on individual requirements.

To enable our customer to use external scripts quickly and easily by default, we are including a feature override plugin for the **Python** scripting language that we developed with version 2022.

The corresponding files for the **Python feature override plugin** are in the directory of a standard installation of Smapi3D Plant Design 2022: *C:\Program Files\CAD-Partner\Smapi3D Plant Design 2022\Custom\Isometric.Python*

Read and follow the **Readme.txt** included there to put this plugin into operation if needed.

Support of reducers with fabricated branches as individual parts

Until now, when deriving isometric drawings, fabricated branches (e.g., with olet) on concentric and eccentric reducers were only supported if the required individual parts were previously created as a separate assembly and placed as a unit on the pipeline paths.

Such a predefined assembly had to have additionally the appropriate **-TEED** ComponentType, as well as the appropriate SKEY for the combination of the included fittings.

As of version 2022, we have improved the isometric generation for such fitting combinations as single parts.

For the most of such fabricated branching situations in a 3D pipeline, the placed individual parts of the piping automatism can now be used for an isometric drawing.

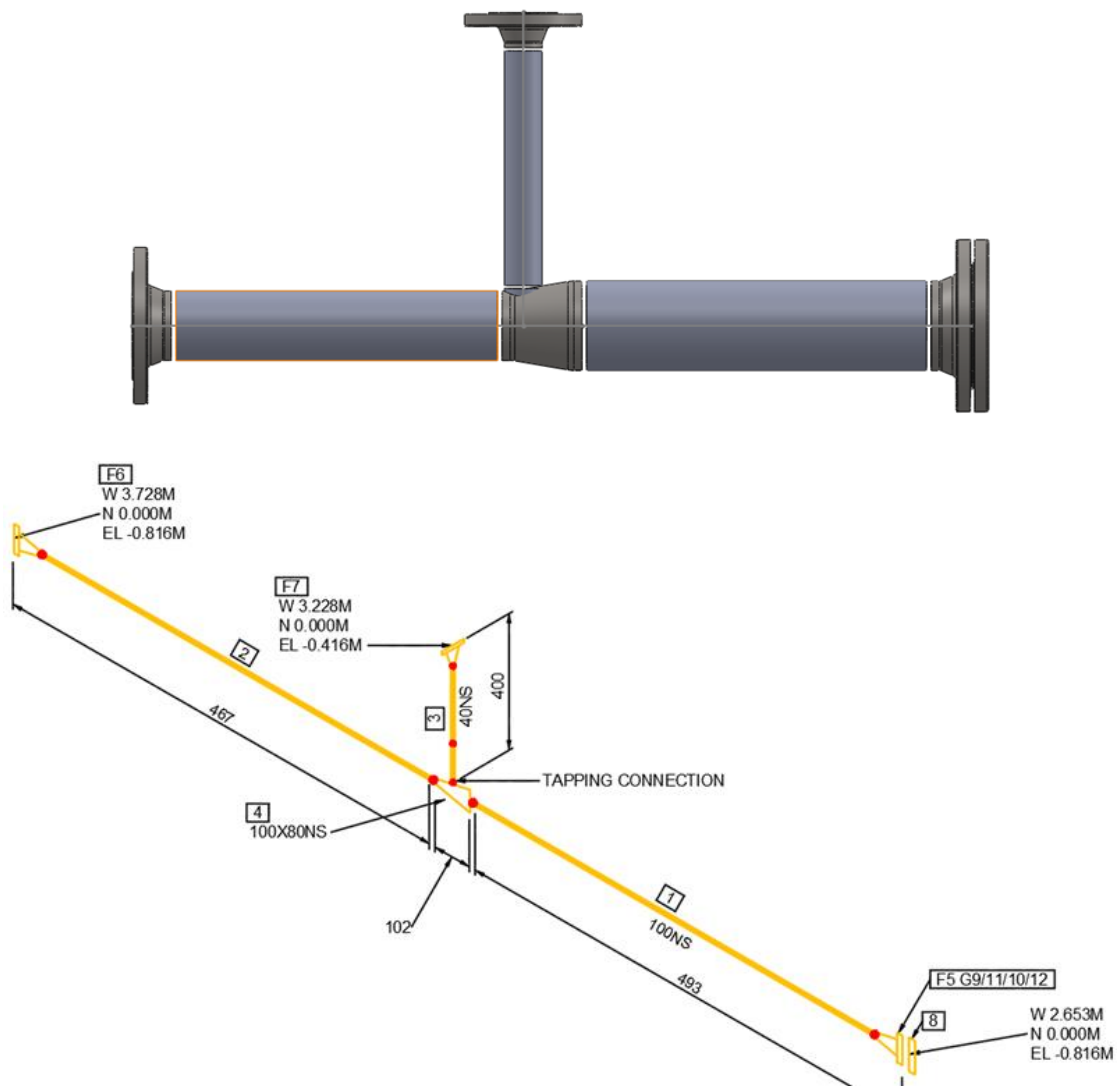

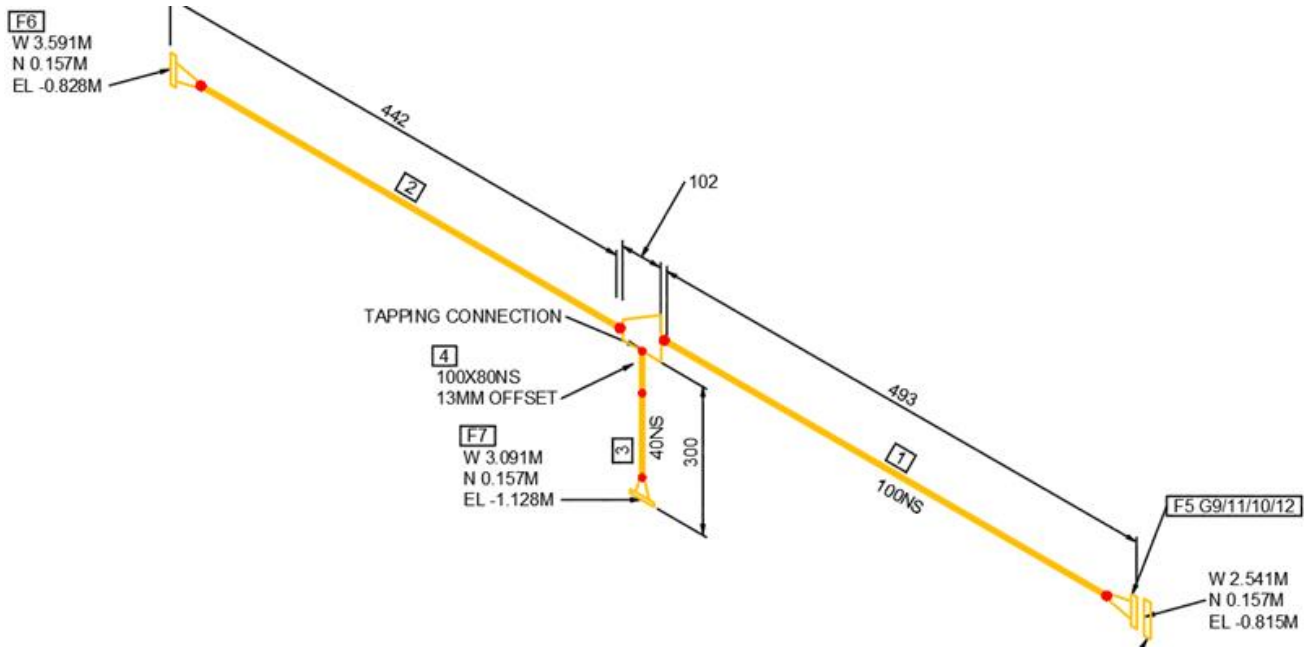
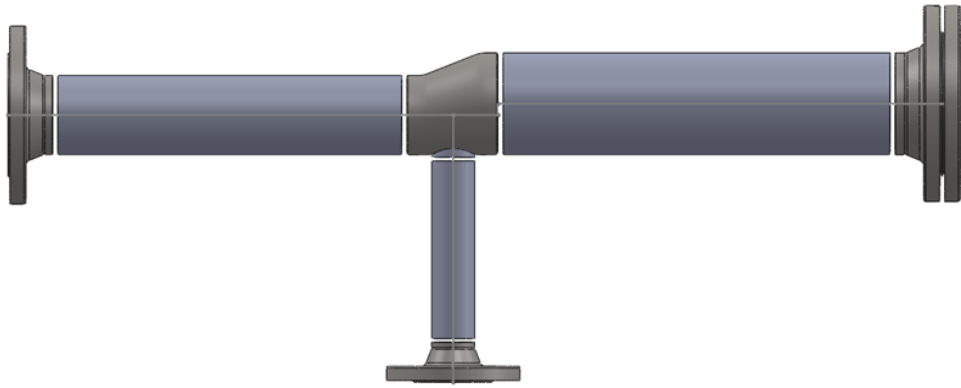

Support of elbows with fabricated branches as individual parts

The same limitations existed with elbows. If fabricated branches (e.g., with outlet) were required, separate assemblies also had to be created beforehand and placed as a unit to the pipeline path.

We have also improved the isometric derivation for this use case when using individual parts.

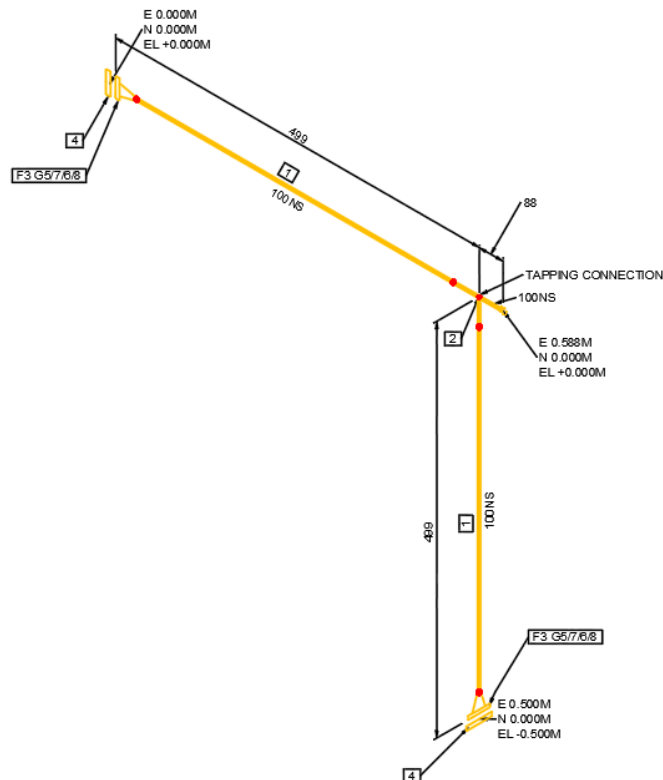

Pipeline path marked in Isometric window is highlighted in 3D CAD

As of version 2022, when working with any of the supported CAD systems, the pipeline path is now highlighted in CAD working window if it is selected in Isometric Step 2.

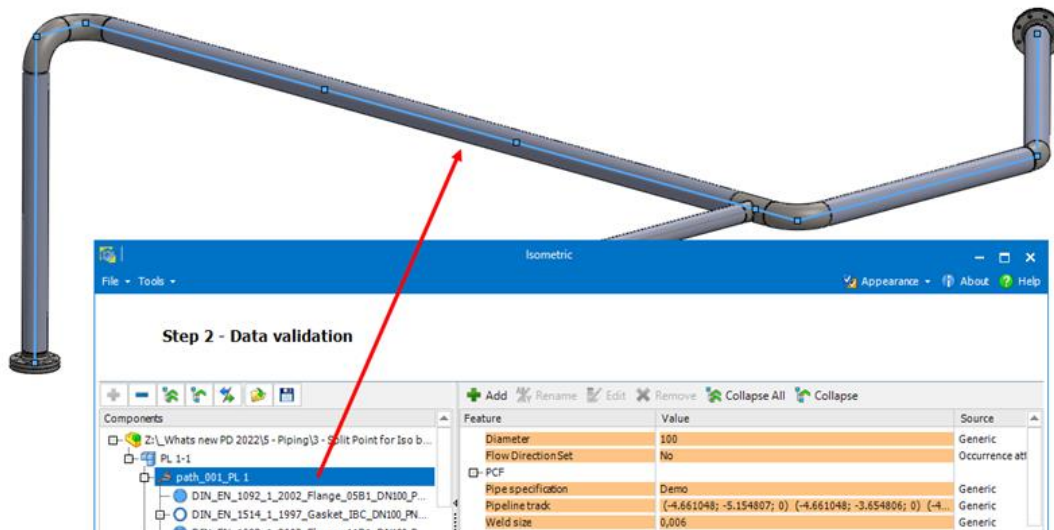

Mapping of properties of a path to the placed components

When creating feature overrides with the formula editor, the new parameter **PIPELINE-REF-** has been added.

This parameter can be used to map properties of pipeline paths, to the components on these paths.

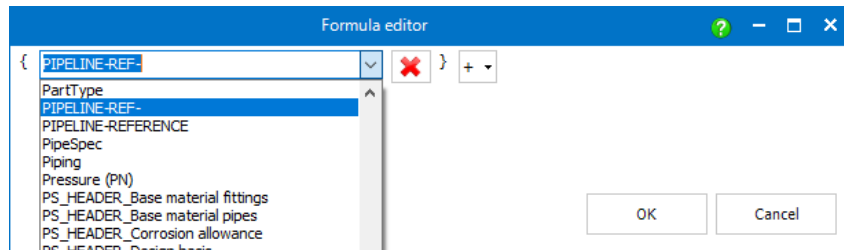

In a first row (in the picture the property **Path-Property**) is defined which existing attribute of paths, should be mapped to their components.

In a second row (in the picture the property **MappedToComponent**), the new parameter **PIPELINE-REF-** is used together with the **Name of the first row** to specify which property name should be used to display the mapped value at the components.

Priority	Feature name	New value	Filter feature	Filter value	Component role
1	Path-Property	{ISO_PIP_DN}			Pipeline
1	MappedToComponent	{PIPELINE-REF-Path-Property}			Fitting

Once the feature override definitions are complete, the results are displayed immediately at the respective entries in step 2.

Feature	Value	Source
Material	P235GH	Occurrence attribute
Material No.	1.0345	Occurrence attribute
Path-Property	100	Feature override
Pressure (PN)	PN 10	Occurrence attribute
PS_HEADER_Base material fittings	P235GH / P245GH	Occurrence attribute
ISO InstanceID	1	Generic
MappedToComponent	100	Feature override
Material	P235GH	Occurrence attribute

Isometric reads property Occurrence number of components

Isometric 2022 can now also evaluate the value of the occurrence number of a component as the separate property **ISO_InstanceID** and list it in step 2.

Thus, this property (its value) is available as separate information for feature overrides and output mappings.

Visual navigation	S91.S03.S070.S0201490	Category info
•AppVersion	30.0.0.5041	Occurrence attribute
•Bend radius	152	Category info
•CadFittingType	1	Occurrence attribute
•Diameter (DN)	100	Occurrence attribute
•Druckstufe (PN)	PN 10	Occurrence attribute
•Insulated	False	Occurrence attribute
•InsulExtEnd	0	Occurrence attribute
•InsulExtStart	0	Occurrence attribute
•IsColored	False	Occurrence attribute
•ISO_InstanceID	2	Generic
•MappedToComponent	100	Feature override
•Material	P235GH	Occurrence attribute
•Material No.	1.0345	Occurrence attribute
•MethodID	QP_Bend90	Occurrence attribute
•Nominal size (DN)	100	Category info
•OUTPUT_POINT_1_CSInfo	IO=0 GR=0 SN=1 ET=3 SZ=DN100 OD=...	Custom property
•OUTPUT_POINT_2_CSInfo	IO=0 GR=0 SN=2 ET=3 SZ=DN100 OD=...	Custom property

New option to set file extension for purging

More and more customers are using the options in I-Configure to generate individual and external report files for their Isogen styles when creating drawings. These files are then located in the defined output folder in addition to the drawing files.

Previously, only certain file formats were internally hard coded for the **Purge output folder** function, so that when purged, all other files remained in the output folder and had to be manually deleted by the user.

To make the **Purge output folder** function more powerful and flexible, there is now the definition option of **Extensions to purge**.

In this field, each customer can individually specify the files extensions that should be automatically deleted from the output folder during cleanup.

PCF Templates Advanced Feature overrides Output mappings Custom symbols

Output path:

Same as assembly

C:\Smapp3D_PlantDesign\Isometric\IsoOutput

Purge output folder(s)

Extensions to purge: DWG, DXF, MES, TXT



Smap3D Plant Design GmbH

Am Marktplatz 7
93152 Nittendorf
Germany

Phone.: +49 9404 9639-10

Fax: +49 9404 5209

info@smap3d.com

www.Smap3D.com

©2022 Smap3D Plant Design GmbH. All rights reserved.

These documentations respectively training materials are copyrighted works.

The copyrights belong solely to Smap3D Plant Design GmbH.

Reproduction, publication, modification, or translation - also in the form of excerpts - is not allowed without the express permission of Smap3D Plant Design GmbH.

The information in these documents is subject to change without notice and does not constitute an obligation on the part of Smap3D Plant Design GmbH.

The content has been carefully checked.

However, Smap3D Plant Design GmbH assumes no liability for any errors or omissions.

Smapp3D is a Trademark of CAD Partner GmbH. All other names, registered trademarks and product names are used herein are the property of their respective holders.